

DLaxV Regelwerk Box Lacrosse



Gemäß BSO §14



Inhalt

Folgende Regeln und Regelwerke gelten für den DLaxV Spielbetrieb (**neu in gelb**):

S.3 Regeln für den DLaxV Spielbetrieb

S.4 World Lacrosse Regelwerk: 2024 Box Lacrosse Official Playing Rules



Regeln für den Spielbetrieb im DLaxV

Es gibt aktuell keine abweichenden Regeln für den DLaxV Spielbetrieb.



**WORLD
LACROSSE™**

**2024
BOX LACROSSE
OFFICIAL PLAYING RULES**

The text herein is provided by World Lacrosse (WL) and is published with their permission. These Official Rules of Box Lacrosse are the 2024 edition of this rule book.

New rules and rule changes approved in Peterborough Ontario, Canada at the 2019 World Lacrosse *General Assembly are in italics and underlined in this rulebook.*

All references to “non-playing personnel”, such as: referees, bench officials, coaches, team staff and others have been changed to a non-gender reference for this edition of the Rule Book. These changes are in italics and underlined in this rulebook. To be inclusive of the men and women who compete in this discipline, all player references will in the gender-neutral format, generally “athlete” and/or “player”. These changes do not impact the specific rule in itself.

World Lacrosse publishes these Official Rules of Box Lacrosse in English. All rules and regulations in this rulebook are detailed in English. This rulebook may be translated to any language other than English. Any non-English translations are not sanctioned or endorsed by WL. If there is a conflict between the official World Lacrosse Rulebook and an alternate language translation of the rulebook, the current version of the Official World Lacrosse English language rulebook is deemed authoritative and will prevail.

Please direct any inquiries, rule suggestions or questions of rule interpretations to:

Your national association Referee-In-Chief; and

Copy your inquiry to World Lacrosse Chair of Box Rules: Scott Browning at sbrowning@worldlacrosse.sport

Copyright 2024 – World Lacrosse.

Colorado Springs, Colorado, USA

Table of Contents

SECTION 1	THE ARENA.....	9
RULE 1.1	THE PLAYING SURFACE.....	9
RULE 1.2	GOALS.....	9
RULE 1.3	GOAL CREASES.....	9
RULE 1.4	NETS.....	10
RULE 1.5	FACE-OFF SPOTS.....	10
RULE 1.6	TEAM BENCHES.....	10
RULE 1.7	TIMER/SCORER AREA.....	10
SECTION 2	TIME FACTORS.....	10
RULE 2.1	LENGTH OF GAME.....	10
RULE 2.2	INTERVALS BETWEEN QUARTERS.....	10
RULE 2.3	GAME CLOCK OPERATION.....	11
RULE 2.4	SUDDEN-DEATH OVERTIME.....	11
RULE 2.5	PROPER COMMENCEMENT OF PLAY.....	11
RULE 2.6	TIME-OUTS.....	11
RULE 2.7	REFEREE'S TIME-OUTS.....	12
SECTION 3	THE OFFICIALS.....	12
RULE 3.1	APPOINTMENT OF OFFICIALS.....	12
RULE 3.2	REFEREES.....	13
RULE 3.3	MINOR OFFICIALS.....	13
RULE 3.4	RECORD KEEPING.....	14
RULE 3.5	PUBLIC ADDRESS ANNOUNCER.....	14
SECTION 4	THE TEAMS.....	14
RULE 4.1	PLAYERS ON THE FLOOR.....	14
RULE 4.2	PLAYERS IN UNIFORM.....	15
RULE 4.3	IN-HOME.....	15
RULE 4.4	CAPTAIN OF THE TEAM.....	15
RULE 4.5	UNIFORM REQUIREMENTS.....	16
RULE 4.6	COACHES.....	16
SECTION 5	EQUIPMENT.....	16
RULE 5.1	THE BALL.....	16
RULE 5.2	LACROSSE STICK.....	16
RULE 5.3	GOALKEEPER STICK DIMENSIONS.....	16
RULE 5.4	LACROSSE STICK CONSTRUCTION.....	17
RULE 5.5	PROTECTIVE EQUIPMENT / PADS.....	17
RULE 5.6	EQUIPMENT SAFETY.....	18

RULE 5.7	GOALKEEPER EQUIPMENT.....	18
SECTION 6	PENALTY DEFINITIONS.....	19
RULE 6.1	DEFINITION OF TECHNICAL PENALTIES/CHANGE OF POSSESSION.....	19
RULE 6.2	DEFINITION OF MINOR PENALTIES.....	19
RULE 6.3	DEFINITION OF MAJOR PENALTIES.....	20
RULE 6.4	DEFINITION OF MISCONDUCT PENALTIES.....	20
RULE 6.5	DEFINITION OF GAME MISCONDUCT PENALTY.....	21
RULE 6.6	DEFINITION OF MATCH PENALTY.....	21
RULE 6.7	DEFINITION OF GROSS MISCONDUCT PENALTY.....	21
RULE 6.8	GOALKEEPER PENALTIES.....	21
RULE 6.9	DEFINITION OF PENALTY SHOT.....	21
SECTION 7	FLOW OF THE GAME.....	23
RULE 7.1	PLAY OF THE BALL.....	23
RULE 7.2	FACING AT CENTER.....	23
RULE 7.3	POSITIONING OF ALL PLAYERS FOR THE FACE-OFF.....	24
RULE 7.4	FACING AT OTHER FACE-OFF SPOTS.....	24
RULE 7.5	10-SECOND COUNT.....	24
RULE 7.6	BACKCOURT DEFINITION.....	25
RULE 7.7	30-SECOND SHOT RULE.....	25
RULE 7.8	OUT OF BOUNDS.....	26
RULE 7.9	BALL CAUGHT IN LACROSSE STICK OR EQUIPMENT.....	26
RULE 7.10	BALL OUT OF SIGHT.....	26
RULE 7.11	BALL STRIKING A REFEREE.....	26
RULE 7.12	GOAL SCORED DEFINITION.....	26
RULE 7.13	NO GOAL.....	27
RULE 7.14	SUBSTITUTION.....	27
RULE 7.15	CRITERIA FOR STOPPAGE OF PLAY ON A DELAYED PENALTY.....	28
RULE 7.16	INJURED PLAYERS.....	29
SECTION 8	INFRACTIONS.....	29
Section 8a	Technical Infractions.....	29
RULE 8.1	POSSESSION/TECHNICAL INFRACTIONS.....	29
RULE 8.2	OFFENSIVE SCREENS/PICKS/BLOCKS.....	30
RULE 8.3	HANDLING THE BALL.....	30
Section 8b	Stick Infractions.....	31
RULE 8.4	BUTT ENDING.....	31
RULE 8.5	HIGH STICKING.....	31
RULE 8.6	ILLEGAL CROSSCHECKING.....	31
RULE 8.7	SPEARING.....	31
RULE 8.8	THROWING THE STICK.....	32
RULE 8.9	SLASHING.....	32

Section 8c	Crease Infractions.....	32
RULE 8.10	GOAL-CREASE VIOLATIONS	32
Section 8d	Goalkeeper Privileges.....	34
RULE 8.11	GOALKEEPER PRIVILEGES	34
RULE 8.12	CONTACT WHILE SHOOTING ON NET	34
Section 8e	Restraining Infractions	37
RULE 8.13	ILLEGAL BODY CHECKING	37
RULE 8.14	HOLDING	37
RULE 8.15	HOOING.....	38
RULE 8.16	INTERFERENCE BY/WITH SPECTATORS	38
Section 8f	Physical Infractions.....	39
RULE 8.17	BOARDING	39
RULE 8.18	SPEARING WITH YOUR HEAD	39
RULE 8.19	CHECKING FROM BEHIND	39
RULE 8.20	DANGEROUS CONTACT TO THE HEAD.....	39
RULE 8.21	ELBOWING.....	40
RULE 8.22	FACE MASKING	40
RULE 8.23	FIGHTING.....	40
RULE 8.24	HEAD BUTTING	42
RULE 8.25	INTENTIONAL CONTACT DURING DEAD BALL SITUATIONS.....	42
RULE 8.26	KNEEING	42
RULE 8.27	KICKING A PLAYER	43
RULE 8.28	ROUGHING.....	43
RULE 8.29	TRIPPING.....	43
RULE 8.30	ABUSE OF OFFICIALS	44
Section 8g	Equipment Infractions.....	45
RULE 8.31	EQUIPMENT INSPECTION.....	45
RULE 8.32	BROKEN STICK.....	45
RULE 8.33	EQUIPMENT OR CLOTHING ADJUSTMENT	46
RULE 8.34	HELMET LOST DURING PLAY	46
Section 8h	Other Infractions.....	47
RULE 8.35	DELAYING THE GAME.....	47
RULE 8.36	DISPLACEMENT OF GOAL.....	47
RULE 8.37	OBSCENE OR PROFANE LANGUAGE OR GESTURES BY PLAYERS.....	48
RULE 8.38	UNSPORTSMANLIKE CONDUCT	48
RULE 8.39	LEAVING PLAYERS' BENCH OR PENALTY BOX.....	50
RULE 8.40	DISCIPLINE	51
RULE 8.41	GENERAL APPLICATION OF THE RULES.....	51
SECTION 9	ADMINISTRATION OF COINCIDENTAL PENALTIES	53

RULE 9.1	COINCIDENTAL PENALTIES.....	53
APPENDIX A	REFEREE SIGNALS.....	55
APPENDIX B	FIELD OF PLAY DIAGRAMS.....	59
APPENDIX C	HISTORY OF RULE CHANGES.....	61
APPENDIX D	GLOSSARY.....	62
APPENDIX E	WORLD LACROSSE WORLD EVENT RULES.....	62
NOTES		63
NOTES		64

SECTION 1 THE ARENA

Rule 1.1 The Playing Surface

SURFACE - The preferred Box lacrosse-playing surface shall be made of artificial turf material. Where a floor of artificial turf material is not available a concrete floor or other solid material with a smooth finish may be used.

- 1.1.1 **BOARDS** - A wall known as the dasher boards shall enclose the playing surface, and may be constructed of wood and/or plastic. Measured from the surface of the floor, the boards shall not be more than four feet (4') nor less than three feet six inches (3' 6") in height. The boards (dasher boards) facing the playing area, excluding arena advertisers, shall be uniform in color and free from any obstructions or objects that may cause injury. The boards shall be topped by a surrounding barrier of safety glass or other suitable material to a minimum height of three feet (3') on the sides and a minimum height of six feet (6') on the ends to keep the ball in play.
- 1.1.2 **DOORS** - All doors in the playing area shall open away from the playing surface.
- 1.1.3 **LINES** - All lines on the floor or artificial playing surface shall be two inches (2") in width and white in color. The locations of lines are as shown on the WL Regulation Box Lacrosse Floor diagram, see Appendix 1.
- 1.1.4 **CHANGE AREA LINES** - Paint or tape must be used to designate line change areas in front of the team benches. The length of the change area shall be equal to the length of the bench area plus six feet (6') on each side, and the width shall be three feet (3'). Referees shall mark proper dimensions in each arena prior to games. Adjustments may have to be made to suit various arena dimensions. Only lines approved by the Head Referee may be used.
- 1.1.5 **RESTRAINING LINES** - The restraining lines shall be drawn forty-two feet and six inches (42' 6") out from the centerline.
- 1.1.6 **ZONES** - The playing surface shall be divided into three (3) zones, a defensive zone, a center zone, also known as the neutral zone, and an attacking zone. The two restraining lines separate the three zones. What is one team's defensive zone is their opponent's attacking zone. The portion of the floor in which the goal is situated shall be called the "Defensive Zone" of the team defending that goal, and the portion farthest from the defended goal as the "Offensive Zone".

Rule 1.2 Goals

- 1.2.1 *GOAL DIMENSIONS - Each goal shall consist of two vertical posts (goal posts) joined by a rigid top crossbar. These goal posts shall be four feet, nine inches (4' 9") apart, and the top crossbar shall be four feet (4') from the playing surface, all inside dimensions. The goals shall be centered relative to the width of the playing surface. The goal posts and the goal line shall be placed twelve feet (12') from the end of the enclosure, the end boards. The goal posts and crossbar shall be made of one and one half-inch (1 1/2") metal pipes, also measured as two-inch (2") nominal outside diameter and must be painted red or orange.*
- 1.2.2 **GOAL LINE** - A white line shall be drawn two inches (2") wide and between the goal posts to indicate the plane of the goal. It shall be designated as the goal line. Two poles, or flat steel bars, measuring four feet six inches long (4' 6") shall run from the base of the posts until they meet behind the goal. The net shall be secured to these poles/bars, the posts and the top crossbar. A one-inch (1") by one-inch (1") line both above and below the goal line will indicate the correct position of the goal posts.

Rule 1.3 Goal Creases

- 1.3.1 *GOAL CREASE DIMENSIONS - A circle, known as the goal crease, shall be plainly marked around each goal. Mark the goal crease by using the midpoint of the goal line as the center of a circle around that point with a radius of nine feet, three inches (9' 3") to the outside edge of the goal crease circle. The circle shall continue until it reaches a point of intersection with a straight line that runs parallel with the goal line one foot (1') from the point of the base of the goal. The width of the goal crease line shall be a minimum of two (2") inches but no more than five (5) inches. The area of the goal crease may be painted a solid color other than white*

The base of the goal crease shall then run in a straight line parallel to the end boards (Appendix 1, WL Regulation Crease Area).

Rule 1.4 Nets

- 1.4.1 GOAL NETTING- The poles, posts, and crossbars shall be fitted with a cone shape netting of not more than one- and one-half inch (1 ½ ") mesh. Nets must be adjusted so as to permit the ball to pass completely through the imaginary plane of the goal at any place. The netting must fit the goals loosely so the ball will hit the netting and remain inside the goal line. Home club shall supply repair string to the referees. It is a recommendation to use black netting

Rule 1.5 Face-off Spots

- 1.5.1 CENTER FACE OFF - A point on the centerline, equal distant from each side of the enclosed playing surface shall be marked with an "X" or an "O" and designate the center face-off spot. There shall be a dotted circle, centered on the center face-off spot, with an inside radius of seventeen inches (17"). The outside face-off circle, likewise centered on the center face-off spot, has a radius of eleven feet (11').
- 1.5.2 CORNER FACE-OFF - Either an "X" or an "O" shall designate four alternate face-off spots on the floor. The spots are located between the restraining line and the end boards. Each spot is five (5) yards from the closest sideboards (dasher boards) and five (5) yards inside the restraining lines.

Rule 1.6 Team Benches

- 1.6.1 BENCH SPECIFICATONS - The arena shall provide seats or benches for the use of players of both teams. The accommodations provided, including benches and doors, shall be uniform for both teams. Such seats or benches shall have accommodation for at least fourteen (14) persons of each team, and shall be placed immediately alongside the floor, in the neutral zone, as near the center of the floor as possible with doors opening in the neutral zone and, to the rear convenient to the dressing rooms. Each team bench shall be a minimum of twenty-four feet (24) in length, and when situated in the spectator area, they shall be separated from the spectators by protective glass of sufficient height so to afford the necessary protection of the players. The players' benches shall be on the same side of the playing surface, opposite the penalty bench and shall be separated by a substantial distance, and or a physical barrier.
- 1.6.2 NON-PLAYING PERSONNEL ON BENCH - Only players in uniform, the Head Coach, and five non-playing eligible personnel shall be permitted to occupy their team bench. Non-dressed players are not permitted on the bench. Any ineligible personnel will be ordered by the referees to be removed from the bench and corridor. The Head Referee will instruct the Head Coach to order the removal of any offending individuals from the players' benches. After such warning if the team does not conform, or returns to the team bench, a bench minor penalty will be imposed on the offending team.

Rule 1.7 Timer/Scorer Area

- 1.7.1 TIMER AND SCORER LOCATION - The timer's table shall consist of the Official Timer, the 30-Second Clock Operator, the Official Scorer and any assistants. It shall be located on the side opposite of the playing surface from the team benches and, where possible, between the respective team penalty boxes. A copy of the game sheet will be at the timer's table during the game.
- 1.7.2 SHOT CLOCK OPERATOR/STATISTICIANS -The 30-second clock operator shall use an electronic scoreboard buzzer, which they shall activate when the 30-second rule is violated. Any and all statisticians shall be seated in the press box or in as close proximity as possible, but not in the timer and scorer location.

SECTION 2 TIME FACTORS**Rule 2.1 Length of Game**

- 2.1.1 GAME LENGTH -The regulation playing time of a game shall be sixty minutes (60), divided into four quarters of fifteen minutes (15) each.

Rule 2.2 Intervals Between Quarters

- 2.2.1 QUARTER BREAKS -There shall be a 2-minute interval between the first and second quarters and between the third and fourth quarters. During these intervals all rules governing play of the game shall remain in force. Players who are serving a penalty must remain in the penalty box between quarters, except during halftime.

2.2.2 HALF TIME LENGTH - Between the second and third quarters, there shall be a twelve-minute (12) intermission or half time. The teams may leave the bench areas for the half time intermission.

2.2.3 CHANGE OF DIRECTION OF PLAY - At the conclusion of each quarter, including any sudden-death periods, each team shall change the direction of play and defend the goal opposite the end from the goal they were defending.

Rule 2.3 Game Clock Operation

2.3.1 STOP TIME – All game time is stop time. The game and penalty clocks run during all live-ball situations, and stop during all dead-ball situations.

2.3.2 REFEREES' WHISTLE INITIATING CLOCK -The referees' whistle shall indicate clock start and stoppage accordingly. Immediately following a goal as indicated by the referee, the game clock will stop. The timekeeper shall, on the face-off whistle, restarting the game clock.

2.3.3 TIME BETWEEN GOAL AND ENSUING FACE-OFF - After a goal is scored the referee shall endeavor to achieve a face-off as soon as possible to a maximum of 20 seconds. Should one team not be prepared to face-off upon the expiration of twenty seconds (20), the non-offending team shall receive possession. Whenever possible the shot clock shall count down after goals from thirty seconds (30) to ten seconds (10).

Rule 2.4 Sudden-Death Overtime

2.4.1 OVERTIME LENGTH - In the event of a tie score at the end of the regulation game, play shall continue with sudden-death overtime, after a two-minute (2) interval. The period(s) shall be fifteen minutes each until a goal is scored, thus deciding a winner.

2.4.2 DETERMINATION OF WINNER - Should the game go into sudden-death overtime the team scoring the first goal in sudden-death overtime is the winning team. The game ends upon scoring of this first overtime goal.

2.4.3 TIME BETWEEN SUDDEN-DEATH PERIODS - Should more than one overtime period be needed to decide the game, there shall be a two-minute (2) interval between sudden-death periods.

Rule 2.5 Proper Commencement of Play

2.5.1 FAILURE TO START OR RETURN TO PLAY - If a team, when off the floor at the start of the game or at the start of a quarter, or having been ordered or permitted to go off the floor by the referee, fails to go on the floor and start play within five minutes after having been ordered to do so by the referee, the offending team shall forfeit the game, and the matter shall be reported on the game sheet or special incident report.

2.5.2 FAILURE TO START PLAY WHILE ON FLOOR OR TEAM LEAVES FLOOR - If, when both teams are on the floor, one team for any reason shall refuse to start play when ordered to do so by the referee, or shall leave the floor without being ordered or permitted to do so by the referee, the referee shall warn the offending team and allow it fifteen (15) seconds to start or resume play. If at the end of that time the team still refuses to start play, the referee shall impose a two-minute bench minor penalty on the offending team to be served by the in-home player. Should the offending team still refuse to play, the referee shall warn the team that it has five (5) minutes to commence play; failing which the game shall be forfeited. In such case the matter shall be reported on the game sheet or special incident report.

2.5.3 METHOD OF NOTIFICATION TO CLUB - Notification or warning a team under this rule may be given to any one of the following: Club Executive, General Manager, Coach, or Captain.

Rule 2.6 Time-Outs

2.6.1 TIME-OUT ALLOCATION AND LENGTH - Each team shall be allowed one (1) time-out per half. No carryover time-outs are permitted. They shall be forty-five (45) seconds in duration. They cannot be carried over if not used from half to half. One time-out shall be awarded for each period in sudden death and they cannot be carried from period to period. During live ball situations a team must have possession in order to request a time out. During dead ball situations any team can request a time out provided the team has not used their allotted time out.

Team time-outs administered before the start of the game are charged to the first half. Likewise, team time-outs administered during the half-time break are charged to the second half.

- 2.6.2 TIME-OUT FOR INJURED PLAYER - A time-out for an injured player shall not count as a charged team time-out, provided the injured player is removed from the playing field. The player may not return to the floor until the next non-technical stoppage of play. Violation will result in a bench minor penalty.
- 2.6.3 TIME-OUTS AND PENALTIES SERVED - Players who are serving a penalty must remain in the penalty box during all time-outs.
- 2.6.4 NO TIME-OUTS REMAINING - When a team asks for a time-out and that team has no timeouts remaining, they will be assessed a two-minute delay of game penalty, and the opposing team shall be awarded possession of the ball.

Rule 2.7 Referee's Time-outs

- 2.7.1 REFEREE'S INJURY TIME-OUT - A referee may suspend play at *their* discretion. If a player is injured and in the judgment of the referee the injury is serious, play shall be suspended immediately. Otherwise, the referee shall delay sounding of the whistle until there is team possession.
- 2.7.2 REFEREE'S TIME-OUT FOR BLEEDING - Whenever a player suffers a laceration or wound where oozing or bleeding occurs, a referee shall suspend play at the earliest possible time and the player shall leave the field of play and be given appropriate medical treatment.
The player with blood on their person, uniform or equipment, shall not re-enter the game until the wound has been covered and/or all evident blood disinfected from their uniform or equipment, and the player may not re-enter play until the next non-technical stoppage of play. The player may change to an alternate clean uniform (blood jersey). Violation will result in a two-minute (2) bench minor penalty. If the player is removed and their team uses a team time-out, during which the problem is rectified, the player may continue to participate.

SECTION 3 THE OFFICIALS

Rule 3.1 Appointment of Officials

- 3.1.1 OFFICIATING CREW - The Officiating Crew shall be appointed by the appropriate league, tournament, or event administer, sport governing body or their delegate.
- 3.1.2 MINOR OFFICIALS - The Host Club is responsible for securing a Game Timekeeper, two penalty box attendants, Official Scorer, and a 30-Second Shot Clock Operator.
- 3.1.3 TREATMENT OF OFFICIALS - All referees and minor officials must be treated with proper respect at all times by all players and non-playing personnel of all teams
- 3.1.4 UNIFORM - The referees shall all wear similar uniforms. For all WL events and those recognized and or approved by the WL, including but not limited to the WL World Indoor Lacrosse Championship,
the referees shall wear:
- Long sleeve, vertical black and white striped shirt; or
 - Short sleeve, vertical black and white striped shirt; and
 - Black long trousers, or shorts with black socks; and
 - Black belt; and
 - Black athletic shoes; and
 - Black helmet with visor

For all WL events and those events recognized and or approved by the WL, including but not limited to the WL World Indoor Lacrosse Championship, the WL board must approve variations to the above uniform.

Rule 3.2 Referees

- 3.2.1 REFEREES - Three (3) on-floor referees shall control the game. One shall be designated the Head Referee. Their duties shall be equal in all respects except that in the settlement of any dispute the decision of the Head Referee shall be final. The Head Referee may consult with other referees before making their decision
- 3.2.2 HEAD REFEREE DUTIES - HEAD REFEREE DUTIES - The Head Referee shall have general supervision of the game and have full control of the game referees, minor officials, players, and non-playing team personnel during the game, including stoppages; and in case of any dispute, their decision will be final. The referees shall remain on the floor until all players have proceeded to their locker rooms at halftime and at the end of game unless, the referees have reason to believe there is a potential for a confrontational situation with the referee crew.
- 3.2.3 DUTIES REGARDING MINOR OFFICIALS - The referees shall, before the start of each game, see that the appointed Game Timekeeper, and Official Scorer are in their respective places and ensure that all timing and signaling equipment are in order.
- 3.2.4 DUTIES REGARDING RULES ADMINISTRATION - It shall be the referees' duty to impose penalties as prescribed by this rulebook for infractions thereof
- 3.2.5 COMMUNICATION OF PENALTIES - The referees shall announce to the Official Scorer or Penalty Timekeeper all penalties, and for what infractions such penalties are imposed
- 3.2.6 SEPARATING PLAYERS IN THE PENALTY BOX - The referee shall see that players of opposing teams are separated in the penalty box to prevent any altercations.
- 3.2.7 SUBMITTING REPORTS - The referee shall report in detail on the game sheet or special incident report any of the following incidents:
- i) When a stick or part thereof is thrown outside the playing area; or
 - ii) Every obscene gesture made by any person involved in the playing or conduct of the game, whether a participant, or as an official of either team or of the league, which gesture they have personally observed or that has been brought to their attention by any game referee or official; or
 - iii) Any altercation between a spectator and any player or non-playing team member; or
 - iv) Every infraction assessed as, a match, a game misconduct, or a gross misconduct

Rule 3.3 Minor Officials

- 3.3.1 TIMEKEEPER'S DUTIES - The Official Timekeeper shall keep an accurate account of the time of each quarter and intervals between quarters and all other time-outs. The timekeeper sounds their horn to resume play when an interval or time-out has elapsed. The timekeeper's horn in and of itself never stops the play of the game.
- 3.3.2 30-SECOND CLOCK OPERATOR DUTIES - The 30-second clock operator shall control a separate timing device that shall be used during the entire game including overtime except for the last thirty seconds (30) in each quarter. Although the 30-second clock operator may sound a horn or electronic device when the 30-second clock expires, the referee shall be responsible to signal any violation of the 30-second clock.
- 3.3.3 SCOREKEEPERS DUTIES - There shall be an Official Scorer and at least one assistant assigned for each game. The Official Scorer shall keep an accurate record of the goals scored, time of the goal scored and assists made by each team. The Official Scorer shall record the name and number of the player scoring the goal and those credited with the assists.

The scorer shall keep an accurate record of time-outs (team, referee's, broadcast) and notify the referees if either team exceeds the number allowed. The scorer keeps the name and number of each player upon whom a penalty is administered, the type of penalty, time of the quarter when it occurred and the duration.

The scorer must notify the referees when any player accumulates two (2) 5-minute penalties (automatic game misconduct). The

scorekeeper shall keep a record of both clubs' in-home player's name and number, who will serve any bench minor penalty assessed, including illegal substitution penalties.

Rule 3.4 Record Keeping

In order to make records uniform the following definitions shall be strictly adhered to:

- 3.4.1 GOALKEEPER SAVES - Anytime a shot is stopped or deflected with any part of the goalkeeper's body or lacrosse stick, or hits the goal post or cross bar a save is recorded.
- 3.4.2 SHOT - A shot shall be defined as a player with possession throwing the ball at the goal in an attempt to score.
- 3.4.3 SHOT ON GOAL - A shot on goal shall be defined as a shot where the ball makes contact with any part of the goalkeeper while the goalkeeper is in their crease area, or the goalposts, or crossbar, or crosses the goal line. The lacrosse stick of the goalkeeper is considered as being part of the goalkeeper's body while within the crease area.

When a shot hits a part of the goal post and does not go in and the ball continues in play, a shot on goal is awarded and a save is credited. To be credited as a shot on goal the head of the player's stick must be equal to or in front of the goal line extended.

- 3.4.4 ASSIST - Any pass or two passes, by a player or players to a teammate who then scores a goal is an assisted goal. Only a goal or an assist however may be credited to any one player on a scoring play. There shall be a maximum of two assists on each goal scored.
- 3.4.5 LOOSE BALL - Any ball that is non-possessed on the ground and in the field of play, which comes into the possession of either team in live-ball play, can be a loose ball. When such a loose ball is obtained, the player gaining the loose ball must be able to perform immediately the normal functions of possession (shoot, cradle, pass). Should any of these conditions not be met, a loose ball should not be awarded. A player may not drop the ball of their own volition, regain possession, and be credited with a loose ball. Loose balls should be awarded as part of the face-off play; however a loose ball is not always awarded when the referee signals possession on a face-off play, since *their* definition of possession does not rise to the standard of that of this loose ball definition.
- 3.4.6 TECHNICAL VIOLATIONS - A technical violation shall be defined as any awarding of possession resulting from technical violations such as, an illegal pick, crease violation, thirty seconds violation. Other violations are listed throughout the rulebook.

Rule 3.5 Public Address Announcer

- 3.5.1 PUBLIC ADDRESS ANNOUNCER DUTIES FOR AWARDED GOALS - The name of the scorer and any player entitled to an assist will be announced by the public address announce system. Public address announcers shall not communicate derogatory or disparaging comments towards any individual players on the opposing team or towards the referees or officials.

Failure to do so may result in a discipline to the home team.

- 3.5.2 PUBLIC ADDRESS ANNOUNCER DUTIES FOR NON-AWARDED GOALS: The PA announcer shall announce over the public address system the reason for not allowing a goal. In the event that the referee disallows a goal for any violation of the rules, *they* shall report the reason for disallowing the goal to the Official Scorer who shall have the PA announcer communicate the referee's decision correctly over the public address system at the next stoppage of play.
- 3.5.3 PUBLIC ADDRESS ANNOUNCER DUTIES FOR PENALTIES - The infraction of the rules for which each penalty has been imposed will be announced correctly, as reported by the referee, over the public access system. Where players of both teams are penalized on the same play, the penalty to the visiting player will be announced first. After a penalty has been announced, the announcer will indicate floor strength, indicating either even strength or a power play or a player down situation.

SECTION 4 THE TEAMS

Rule 4.1 Players on the Floor

- 4.1.1 NUMBER OF PLAYERS TO BEGIN A GAME - A full team shall be composed of six (6) players on the floor.

Rule 4.2 **Players in Uniform**

- 4.2.1 ELIGIBLE PLAYER LIST - At the beginning of each game, the General Manager or Head Coach shall list the players and goalkeepers who shall be eligible to play in the game
- 4.2.2 During all games not more than (20) players including the goalkeepers shall be permitted. The twenty (20) players shall be comprised of eighteen (18) runners, and two (2) goalkeepers, if available. At no time shall a team be comprised of more than eighteen (18) runners.
- 4.2.3 SUBMISSION OF ELIGIBLE PLAYER LIST - Two identical lists indicating the names and numbers of all 18 players and 2 goalkeepers, if available, in the line-up plus other eligible players and goalkeepers must be handed to the Head Referee at the referee's room no later than 30 minutes before the game and no change, with the exception of an injury or sickness during warm up, shall be permitted in the list or addition thereto. The Head Referee will give the home game minor officials one copy of each team's list, while the clubs will receive the opposing teams list at that time. The name of the Captain and the Alternate Captains of both teams shall be included in the list. Also, each club's designated in-home player will be indicated on the line-up and penalty summary sheet.
- Should an injury/sickness occur during warm up the club must notify the Head Referee before the end of the formal warm up in order for an eligible replacement to be made at that time. The opposing club shall be immediately notified by the Head Referee and allowed line up change(s) not to exceed the original club's changes at that time. The Head Referee shall notify the official scorer of any line up changes.
- 4.2.4 ONE GOALKEEPER ON FLOOR - Each team shall be allowed one goalkeeper on the floor at any time during the game. The goalkeeper may be removed and another player substituted. Such substitute shall not be permitted the privileges of the goalkeeper.
- 4.2.5 GOALKEEPER SUBSTITUTE - Prior to the start of the game, each team shall have on its bench, or on a chair immediately beside the bench, a substitute goalkeeper, if available, who shall at all times be fully dressed and equipped and ready to play.
- 4.2.6 RUNNER AS A GOALKEEPER - Except when the rostered goalkeeper(s) is unavailable, no player in the playing roster in that game shall be permitted to wear the equipment of the goalkeeper.
- 4.2.7 GOALKEEPERS POSITION IN QUARTERS - Goalkeepers shall be in the goal closest to their players bench in the first and third quarters and at the goal farthest to their respective benches in the second and fourth quarters

Rule 4.3 **In-Home**

- 4.3.1 The designated in-home may be any runner on the team. A goalkeeper cannot be designated as the in-home. The in-home player will serve any non-designated player penalty, bench minor, or minor penalty to the goalkeeper.

Rule 4.4 **Captain of the Team**

- 4.4.1 CAPTAIN PRIVILEGES - Each team shall appoint one captain, and the captain alone shall have the privilege of discussing with the referee any questions relating to interpretation of rules, which may arise during the progress of the game. No playing coach, playing manager or goalkeeper shall be permitted to act as captain or alternate captain. The captain shall wear the letter "C", approximately three inches (3") in height and in contrasting color, in a conspicuous position on the front of their jersey. In addition, if the permanent captain is not on the floor, alternate captains, not more than two (2), shall be accorded the privileges of the captain. Alternate captains shall wear the letter "A" approximately three (3") in height and in contrasting color, in a conspicuous position on the front of their jerseys.
- 4.4.2 CAPTAIN NOT IN UNIFORM - Only when the captain is not in uniform, the coach shall have the right to designate three (3) alternate captains. This must be done prior to the start of the game. Should a club exceed the limits of designated captains the referees shall instruct the club's Head Coach to correct the situation.
- 4.4.3 CAPTAIN'S COMMUNICATION WITH REFEREES - Only the captain when invited to do so by the referee, shall have the privilege of discussing any point relating to the interpretation of the rules.
The Captain needs to ask the referee to speak, before discussing the interpretation of the rules. Any player, including the captain who positions himself at the referees' crease to converse with the referees without the referee's permission shall be automatically assessed an unsportsmanlike conduct minor penalty.

A complaint about a penalty is NOT a matter “relating to the interpretation of the rules” and a minor penalty shall be imposed against any captain or other player making such a complaint.

Rule 4.5 Uniform Requirements

- 4.5.1 NUMBER ON JERSEY - Each player and goalkeeper listed on the club's roster shall wear an individual identifying number at least ten inches (10") high on the back of their jersey. All players of each team shall be dressed uniformly with, as a minimum, matching jerseys and shorts. A player's name can be added to back of jersey if desired
- 4.5.2 ALTERED UNIFORMS - Altered uniforms of any kind will not be permitted, including but not limited to a ripped and/or re-stitched jersey. Any player or goalkeeper not complying with this rule shall not be permitted to participate in the game.

Rule 4.6 Coaches

- 4.6.1 HEAD COACH DUTIES - It shall be the responsibility of the head coach to see that their players and substitutes are properly and legally dressed and equipped to play and are ready to play at all times in accordance with the pre-game and game procedures set out by WL rules.

The head coach is responsible for the actions of all non-playing members of their squad and all persons officially connected with their team. It is the duty of the head coach to cooperate with the referees in keeping the game under control at all times with their players and not to entice poor sportsmanship from the spectators. Failure will result in a bench minor penalty and may be subject to additional discipline.

SECTION 5 EQUIPMENT

Rule 5.1 The Ball

- 5.1.1 APPROVED BALL - The balls shall have a smooth surface and be a solid color. Specifications are a solid rubber ball measuring between 7.75 inches (19.69 centimeters) and 8.00 inches (20.32 centimeters) in circumference, and 5.00 ounces (141.75 grams) to 5.25 ounces (148.84 grams) in weight. The home team shall supply the game balls to the official scorer area 30 minutes prior to game time and continue to supply as required. The ball in use at the end of the game shall become the property of the winning team

Rule 5.2 Lacrosse Stick

- 5.2.1 STICK LENGTH - The lacrosse stick shall be an overall fixed length of forty (40") to forty-two inches (42") except the goalkeeper's lacrosse stick.
- 5.2.2 STICK WIDTH - The head of the lacrosse stick shall measure between four and one-half inches (4 ½") and seven inches (7") at its widest point, inside measurement except for the goalkeeper's lacrosse stick.
- 5.2.3 BALL STOPPERS - A maximum of one guard stop at the throat of the stick must be a minimum of 10 inches (10") from the head to the nearest edge (closest to the handle) of the stop.
- 5.2.4 POCKET DEPTH - The depth of the pocket shall not exceed five inches (5") measured from the top outside edge of the sidewalls. Nothing may be added to or attached to the outside of the stick except as noted in Rule 5.4, Lacrosse Stick Construction, immediately below.

Rule 5.3 Goalkeeper Stick Dimensions

- 5.3.1 GOALKEEPER STICK DIMENSIONS - The maximum width shall be no more than thirteen inches (13") measured to the outside edges. The maximum length measured from the top of the head to the bottom of the throat shall be no more than sixteen- and one-half inches (16 ½").

The length of the entire stick shall be between forty inches (40") and seventy-two inches (72"). Any significant increase in radius on the shaft with tape or other material that would give undue assistance in goal is not permitted as per the referee's discretion. The diameter of the shaft of the stick, at its widest point shall, be 2 inches (2").

Rule 5.4 Lacrosse Stick Construction

- 5.4.1 STICK MATERIAL - The lacrosse stick shall be made of a hollow synthetic or metal type material, with the head attached directly to the handle. The stick handle (shaft) may not be filled with any substance.
- All other lacrosse sticks are ILLEGAL. Any significant increase in radius on the stick shaft with tape or other material that would give undue assistance is not permitted as per the referee's discretion.
- 5.4.2 BUTT END MATERIAL - The stick handle (shaft) must have a plastic or rubber plug on the end or adequately taped to prevent injury.
- 5.4.3 POCKET COLOR - The pocket shall not be strung nor the strings be of a color(s) or pattern so as to confuse an opponent into believing that the ball is in the stick when it is not, or that the ball is not in the stick when it is.
- 5.4.4 ILLEGAL POCKET AND HEAD - Lacrosse sticks shall not be permitted when the construction or stringing is designed to withhold the ball from play. The ball shall travel between the sidewalls for the entire length of the head section. When the stick is turned parallel to the floor the ball must exit the stick.
- 5.4.5 STICK-CHECK MEASUREMENT REQUEST PROCEDURE - Only the captain, an assistant captain or the head coach may request a stick measurement and dislodgement check and only during a timeout or normal stoppage in play. A request for a stick measurement shall be limited to one request per team during the course of any stoppage of play. If a stick check is requested and the stick is found to be legal, a two (2) minute delay of game penalty will be assessed against the team requesting the stick check. The in-home will serve the bench minor penalty. An immediate stick measurement and dislodgement request following a goal in overtime will not be granted. The referee will perform the measurement and inspection as per Rule 5.2, Lacrosse Stick, Rule 5.4 Lacrosse Stick Construction, or Rule 5.3 Goalkeeper Stick Dimensions, as applicable.
- 5.4.6 ILLEGAL STICK - If a stick is found to be illegal the player using the illegal stick will be penalized two (2) minutes.
- 5.4.7 ILLEGAL STICK & SCORED GOAL - If a goal is scored by an attacking player and before the next live-ball, as a result of a legally requested stick-check measurement, the scorer's stick is found to be illegal, for any reason, then the goal is disallowed. If the goal is disallowed, the minor penalty will not be imposed.
- 5.4.8 RANDOM STICK CHECK PROCEDURE - The referees, between quarters and during time-outs throughout the game, may randomly check the stick of any player. Any player who, in the discretion of the referee, fails to timely provide the stick to the referee upon request or who attempts to alter the stick after the request shall be assessed a minor penalty for unsportsmanlike conduct. Should the stick be illegal upon measurement, an additional minor shall be assessed.
- 5.4.9 CONFISCATION PROCEDURE OF ILLEGAL STICK - If a stick is declared illegal it shall be removed to the penalty box. The team may retrieve the stick immediately after the game.

Rule 5.5 Protective Equipment / Pads

- 5.5.1 REQUIRED EQUIPMENT LIST - All players are required to wear:
- A protective helmet; and
 - Intra-oral mouth-guard; and
 - Facemask and chinstrap; and
 - Protective gloves; and
 - Shoulder/vest pads; and
 - Rib pads.

Straps, strings, tie-dyed or any shirts etc. will not hang below the hemline of the game jersey.

Tape, characters, non-sponsor logos and the like shall not be added to a player's helmet. Team logos and player numbers added to the helmet are legal.

- 5.5.2 COMPRESSION SHORTS - Compression shorts may be worn so long as the players for a particular team who are wearing compression shorts all wear compression shorts of the same color.
- Failure to conform shall result in removal from the floor, and the referee shall instruct the player to correct this situation.

Returning to the floor for the second violation in the game will result in a bench minor delay of game penalty. The offending player serves penalty.

- 5.5.3 HELMET AND FACEMASK BALL AND STICK TEST - The helmet and facemask combination must be approved by either NOCSAE or the CSA, and must pass a "ball and stick test." The lacrosse ball must not be able to pass through any portion of the facemask and touch the face.
The lacrosse stick, held in a horizontal or vertical position must not be able to pass through any portion of the facemask and touch the face. The facemask must cover and protect the entire face area including the chin.
- 5.5.4 HELMET CHIN STRAP - The helmet chin strap or chin cup must be worn in a firmly attached position at all times during play such that there is continuous contact with the strap and or chin cup. Failure to do so will result in removal from the floor. A subsequent violation by the same player will result in a minor penalty for delay of game to the player.
- 5.5.5 MOUTH GUARD - The mouth guard must be worn at all times during a live ball. Failure to do so will result in removal from the floor. A subsequent violation by the same player will result in a minor penalty for delay of game to the player.
- 5.5.6 GOALKEEPER HELMET REMOVED - Should a goalkeeper's helmet/facemask be removed while the goalkeeper is in their crease as a result of a normal goalkeeping duties, play will be stopped immediately. Restart of play will be given to the team who had possession of the ball at the time of the stoppage; otherwise a faceoff will resume play. When a goalkeeper loses their helmet/facemask while they are outside their crease (both feet outside their crease) they are subject to the same rule as non-goalkeepers. A penalty shot will result when a goalkeeper or teammate, intentionally removes the goalkeeper's helmet/facemask to disrupt play. If the opposing team is on a breakaway, the non-offending team is assessed an awarded goal.

Rule 5.6 Equipment Safety

- 5.6.1 DANGEROUS EQUIPMENT - No player shall *wear any form of body or helmet mounted sports camera; or* wear or use any equipment, which in the opinion of the referees endangers the athlete or other players. In such cases, the referee's decision is final. Should a referee deem the equipment is dangerous, the player shall receive a 2-minute minor penalty, and automatic game misconduct.
- 5.6.2 GOALKEEPER EQUIPMENT REPAIR TIME LIMITATION - In the event the goalkeeper loses protective equipment during a stoppage, which cannot be repaired within 30-seconds, the goalkeeper must exit the floor.

If the goalkeeper equipment requires more than 30-seconds to repair, the goalkeeper must be removed from the game and the substitute goalkeeper must be prepared to enter the game no longer than 20 seconds after the original goalkeeper is removed or a bench minor penalty for delay of game will be assessed.

Rule 5.7 Goalkeeper Equipment

- 5.7.1 PURPOSE OF EQUIPMENT - The prime purpose of any goalkeeper equipment is for the protection of the goalkeeper. Special equipment worn by the goalkeeper includes the arm & chest protector, goalkeeper pants, throat guard, athletic cup or pelvis protection, and shin guards.

With the exception of the stick, all the equipment worn by the goalkeeper must be constructed solely for the purpose of protecting the goalkeeper's head or body, and they must not wear any garment or use any contrivance, which would give them undue assistance in keeping goal.

- 5.7.2 APPROVED EQUIPMENT - The following equipment specifications are standardized as follows:
- 5.7.3 GLOVES - A standard lacrosse goalkeeper glove is permitted and may not be altered for purposes of adding bulk. Padding may not be added to the outside of the glove. The glove may be a maximum width of eight and one-half inches (8 ½") at any point across, and fourteen and one-half inches (14 ½") maximum length.
- 5.7.4 PANTS - No internal or external padding is permitted on the pant leg or waist beyond that to provide protection (no outside ridges).
The maximum width (straight line) of the thigh pad across the front of the leg is eleven inches (11"). If the groin and/or hip pads extend beyond the edge of the front thigh pad they are to be included in this eleven-inch (11") measurement.
This measurement is to be taken while the goalkeeper is in an upright standing position.

This measurement is to be made five inches (5") from the bottom of the pant. This measurement will include any shin pad that overlaps the pant.

- 5.7.5 SHIN PADS - The shin pads shall not exceed nine inches (9") in extreme width from the base of the kneecap when on the leg of the goalkeeper. The shin pad shall not exceed *seven* inches (7") in width at the base of the ankle and taper in a straight line from the kneecap to ankle with conformity to leg. Shin pad width at or above the kneecap shall not exceed eleven inches (11"). The measurement shall be taken from the widest points on the plastic only. The entire shin pad shall be no greater than one and one-half inches (1 ½") in thickness and no attachments are permitted.
The calf protector must follow the contour of the calf and ankle, and can have a thickness of no greater than one and one-half inches (1 ½"). Kneepads must be as from the manufacturer, may not be altered, and must conform to the body.

Referees will measure the shin pads when on the leg of the goalkeeper with an approved caliper.

- 5.7.6 HELMET & FACEMASK - Goalkeepers must wear a helmet and facemask approved by and bearing the certification mark of the CSA or NOCSAE. There must also be attached a throat protector.
- 5.7.7 ARM & CHEST PROTECTOR - Shoulder cap protectors must follow the contour of the shoulder cap in a rounded manner without any pointed or squared projections/extensions beyond the shoulder. The contoured padding must not be more than three inches (3") in width outside the said goalkeeper's most outer body point on each side. In addition the padding may not climb higher than two inches (2") above the plane of said goalkeeper's shoulder. The arm padding may not measure more than seven inches across (7") at its greatest point. Referees will measure the arm pad when on the arm of the goalkeeper with an approved caliper.

The chest protector must follow the contour of the chest and abdomen. The contoured padding must not be more than two and one-half inches (2 ½") on each side of the chest and abdomen.

- 5.7.8 JERSEYS - No inserts or additions are to be added to the standard goalkeeper cut jersey as produced by the manufacturer. No "tying down" of the sweater is allowed at the wrists if it creates a tension across the jersey such that a "webbing effect" is created in the armpit area. No other tie downs are allowed that create a "webbing effect".
The length of a jersey is illegal if it covers any area between the goalkeeper's legs
- 5.7.9 SURPLUS PADDING - Surplus padding worn only for bulk shall not be allowed. The protective padding shall conform to the shape of the body. Any surplus padding added must conform to measurement specifications and contour requirements.

SECTION 6 PENALTY DEFINITIONS

Rule 6.1 Definition of Technical Penalties/Change of Possession

- 6.1.1 Technical penalties are less serious in nature and include all violations of the rules of the game except those specifically listed as minor penalties, bench minor penalties, major penalties, misconduct penalties or match penalties.

Rule 6.2 Definition of Minor Penalties

- 6.2.1 MINOR PENALTY - For a Minor Penalty, any player except the goalkeeper shall be ruled off the floor for two (2) minutes.
- 6.2.2 *POSSESSION AFTER MINOR PENALTY - Possession goes to the team fouled, unless the penalty occurs prior to the start of a quarter or overtime period or after the whistle has sounded denoting the scoring of a goal. In these cases the play restarts with a center face-off. If the penalties are simultaneous, possession shall be awarded to the team with the lesser penalty time, or, if penalty times are equal, the ball shall remain with the team in possession at the time of the first infraction, however if ball was loose then a faceoff will restart play.*
- 6.2.3 *BENCH MINOR PENALTY - A Bench Minor penalty involves the removal from the floor of one player from the offending team for a period of two (2) minutes. The designated in-home player shall serve the penalty time.*

Should the in-home player already be serving a penalty, the coach shall designate another player (a runner only) to serve the bench minor.

- 6.2.4 PENALTY RELEASE AFTER GOAL SCORED - If the opposing team scores a goal while a team is short-handed by one or more minor or bench minor penalties, then the first of such penalties shall be automatically terminated.

Short-handed means that the team must be below the numerical strength of its opponents on the floor at the time the goal is scored. Thus, coincidental minor penalties to both teams do NOT cause either side to be short-handed.

- 6.2.5 MINOR PENALTY EXPIRATION CRITERIA -
- i) Is the team scored against short-handed?
 - ii) Are they serving a minor penalty on the clock?

If the answer is yes to both i) and ii), you are to delete the minor penalty with the least amount of time on the clock, except when coincidental penalties are being served.

When the minor penalties of two players on the same team terminate at the same time, the captain of that team shall designate to the referee, which of such players will return to the floor first and the referee will instruct the Penalty Timekeeper accordingly.

- 6.2.6 COINCIDENTAL MINOR PENALTIES - When coincidental minor penalties or coincidental major penalties of equal duration are imposed against players of both teams, the penalized players shall all take their places in the penalty box and teams shall play 5 on 5, full strength. Such penalized players should not leave the penalty box until the first non-technical stoppage of play following the expiry of their respective penalties.

Rule 6.3 Definition of Major Penalties

- 6.3.1 MAJOR PENALTY - For a Major Penalty in any game the offender shall be ruled off the floor for five (5) minutes. If two (2) power play goals are scored on the penalized team, the penalized team may place a player on the floor to get back to even strength. But the offender shall serve the full five (5) minutes and will return to the floor on the next non-technical stoppage of play following the expiration of their penalty.
- 6.3.2 TWO MAJORS IN ONE GAME - For the second major penalty in the same game to the same player, the player shall be ruled off the floor for the balance of the game. The offending player must be replaced in the penalty box by the in-home immediately. When a player receives their second major penalty, the player shall be assessed the major penalty plus a game misconduct.
- 6.3.3 MAJOR AND MINOR ASSESSED UNDER FIVE MINUTES IN REGULATION OR IN OVERTIME - During the last five (5) minutes of regulation time, or at any time in overtime, when a minor penalty and a major penalty are assessed to two opposing players on the same stoppage of play, the three-minute differential shall be served immediately as a major penalty. This is also applicable when coincidental penalties are negated, leaving the aforementioned example. In such instances, the team of the player receiving the major penalty must place the replacement player in the penalty bench prior to expiration of the penalty. The differential will be recorded on the penalty clock as a three (3) minute penalty, and served in the same manner as a major penalty.

Rule 6.4 Definition of Misconduct Penalties

- 6.4.1 MISCONDUCT PENALTY - In the event of Misconduct penalties to players, the players shall be ruled off the floor for a period of ten (10) minutes each.
A substitute player is permitted to immediately replace a player serving a misconduct penalty. A player whose misconduct penalty has expired shall remain in the penalty box until the next non-technical violation stoppage of play.
- 6.4.2 MISCONDUCT PENALTY AND MINOR ASSESSED - When a player receives a minor penalty and a misconduct penalty at the same time, the penalized team shall immediately put the in-home player in the penalty box and he shall serve the minor penalty.
- 6.4.3 MISCONDUCT PENALTY AND MAJOR ASSESSED - When a player receives a major penalty and a misconduct penalty at the same time, the penalized team shall place the in-home player in the box immediately.

Rule 6.5 Definition of Game Misconduct Penalty

- 6.5.1 GAME MISCONDUCT - A Game Misconduct penalty involves the suspension of a player for the balance of the game. For all game misconducts regardless of when imposed, a total of ten (10) minutes shall be charged in the records of the offending player. When warranted, players can receive more than one game misconduct penalty in one game.

Rule 6.6 Definition of Match Penalty

- 6.6.1 MATCH PENALTY - A match penalty involves the suspension of the player for the balance of the game and the offending player shall be ordered to the dressing room immediately. The in-home player shall replace the penalized player in the penalty box for the full five (5) minutes of playing time regardless of the number of goals scored. For all match penalties, regardless of when imposed, or prescribed additional penalties, a total of ten (10) minutes shall be charged in the records against the offending player.
- 6.6.2 MATCH PENALTY AUTOMATIC SUSPENSION - A player incurring a match penalty shall automatically receive a game suspension and shall be subject to further discipline by the appropriate governing body of the game during which the match penalty was assessed.

Rule 6.7 Definition of Gross Misconduct Penalty

The referee may impose a "Gross Misconduct" penalty on any player, Coach, Trainer or Equipment Manager who is guilty of a gross misconduct of any kind. Any person incurring a "gross misconduct" penalty shall be assessed a game misconduct.

For all gross misconducts regardless of when imposed, a total of ten (10) minutes shall be charged in the records of the offending player. The following list of infractions, but not limited to, can result in a gross misconduct being assessed:

- Interfering with or striking a spectator; or
- Racial taunts and/or slurs; or
- Spitting on or at an opponent, spectator or referee.

Rule 6.8 Goalkeeper Penalties

- 6.8.1 MINOR PENALTY TO GOALKEEPER - Minor penalties to the goalkeeper are served by the in-home.
- 6.8.2 GOALKEEPER SERVING MAJOR PENALTY - When a goalkeeper is assessed a major penalty, the penalized team shall put the substitute goalkeeper in goal and place both the in-home player and the penalized goalkeeper in the penalty box immediately. If two (2) power play goals are scored against the major penalty, the in-home player is released immediately from the penalty box while the penalized goalkeeper remains in the penalty box and returns to the floor on the next non-technical stoppage of play following the expiration of the goalkeepers total penalty time.
- 6.8.3 GOALKEEPER SERVING MISCONDUCT - When a goalkeeper is assessed a ten (10) minute misconduct penalty, the goalkeeper must serve their own penalty. When a goalkeeper is assessed a minor and a ten (10) minute misconduct penalty at the same time, the in-home player shall immediately enter the penalty bench to serve the minor penalty.
- 6.8.4 ADMINISTRATION OF GOALKEEPER PENALTIES DUE TO INJURIES - If a goalkeeper is penalized for a major or a misconduct and the substitute goalkeeper is injured and can not continue, the in-home will serve the remaining penalty time and the penalized goalkeeper will be allowed to return. If in the discretion of the referee, a team intentionally uses this rule to gain an advantage an unsportsmanlike conduct penalty will be assessed. When a goalkeeper has been injured, such that they are unable to continue to play, and their substitute is assessed a major or a misconduct, the penalized goalkeeper will remain in the game and a penalty shot will be awarded to the non-offending team and the in-home will serve the appropriate penalty time for the goalkeeper.

Rule 6.9 Definition of Penalty Shot

- 6.9.1 A penalty shot is designed to restore a scoring opportunity which was lost as a result of a foul being committed by the offending team, based on the parameters as set out in these rules. Any dressed player on the offended team may take the penalty shot.

- 6.9.2 TWO PLAYER DOWN AND ADDITIONAL PENALTY TO THIRD PLAYER - If a team is already two (2) players down from full strength and is assessed an additional time penalty to a third player, the non-offending team shall be awarded a penalty shot. Regardless of the outcome of the penalty shot, the floor strength will remain as it was prior to the penalty shot. The team that received the third time penalty will begin play after the penalty shot, two players down from full strength.
- 6.9.3 INSUFFICIENT PLAYING TIME WHEN ILLEGAL SUBSTITUTION PENALTY IS ASSESSED - If by reason of insufficient playing time remaining, or by reason of penalties already imposed, and a bench minor is imposed for illegal substitution (too many players), which cannot be served in its entirety within the legal playing time, or at any time in overtime, the non-offending team shall be awarded a penalty shot.
- 6.9.4 THROWING THE STICK - When any member of the defending team, including anyone on the bench, deliberately throws or shoots any part of a stick or any other object, at the ball or ball carrier on a breakaway or an attacker attempting to pick up a loose ball, the referee shall allow the play to be completed and if a goal is not scored, a penalty shot shall be awarded to the non-offending team.
- 6.9.5 BREAKAWAY DEFINITION - A player with a BREAKAWAY is defined as a player in control of the ball immediately transitioning from defense to offense with an unobstructed path to the goal and a reasonable scoring opportunity. This shall be the definition of a breakaway for this rulebook.
- 6.9.6 CREASE VIOLATION - Should a player in their own end deliberately fall on the ball in their crease in front of their goal line, or deliberately close their hand on the ball in their crease in front of their goal line, a penalty shot will be awarded to the non-offending team. See rule 8.10.16
- 6.9.7 HOLDING - When a player is on a breakaway and is held from behind, a penalty shot shall be awarded to the non-offending team.
- 6.9.8 TRIPPING - When a player is on a breakaway and is tripped or otherwise fouled from behind, a penalty shot shall be awarded to the non-offending team.
- 6.9.9 INTENTIONAL DISPLACEMENT OF THE GOAL ON A BREAKAWAY - If the goalkeeper or a defending player deliberately displaces the goal post during the course of a breakaway, a penalty shot will be awarded to the non-offending team. The referee will stop play immediately and award the penalty shot.
- 6.9.10 ILLEGALLY ENTERING THE GAME AND INTERFERING WITH BALL CARRIER ON A BREAKAWAY - If a defending player, who has illegally entered the game, interferes with a player on a breakaway, the referee shall award a penalty shot to the non-offending team. Interfered as per this rule, does not imply physical contact by the defender.

SECTION 7 FLOW OF THE GAME

Rule 7.1 Play of the Ball

The following definitions shall prevail in the play of the ball:

- 7.1.1 FREE PLAY - Whenever a player has been awarded possession for any reason, no opposing player may take a position closer than two yards.
- 7.1.2 PLAYER POSSESSION - A player shall be considered in possession of the ball when that player has control of the ball and can perform any of the normal functions of ball control such as carrying, cradling, passing or shooting.

Any defender or goalkeeper, whether inside or outside the crease, who clamps down with their stick on the ball while the ball is in the crease is defined as having possession.

It is illegal to check any player or goalkeeper, whether that player is inside or outside the crease, when they clamp down with their stick on the ball while the ball is in the crease.

- 7.1.3 TEAM POSSESSION - A team shall be considered in possession of the ball when a player of that team has possession. A ball being passed from teammate to teammate is considered team possession.
- 7.1.4 PASS - The movement of the ball caused by a player in possession, throwing, or bouncing, or rolling the ball to a teammate. If a player bounces the ball onto the floor and then into the board and/or glass and toward the stick of a teammate and there is continuous movement of the ball, this is considered a pass.
- 7.1.5 COMPLETED PASS - A completed pass is one caught by a teammate.

7.1.6 Definition of a Non-technical Stoppage

There are multiple references to a 'Non-technical Stoppage' in this rulebook including the conditions for releasing coincidental non-time served penalties and returning a player to the floor who was previously removed because of injury. A non-technical stoppage in play is any stoppage of play where a fast restart is not expected. Since the game is built on fast restarts, there are only a few circumstances where the Non-technical Stoppage is possible. They are as follows:

- After a goal is scored
- Administration of a penalty or penalties
- A timeout called by a team or the officials (includes media timeouts)
- The end of a period

A ball out of bounds is a fast restart and NOT a non-technical stoppage since the officials will produce a new ball and restart play immediately.

Rule 7.2 Facing at Center

- 7.2.1 BEGINNING THE GAME - Play shall be started at the beginning of each quarter or overtime period and after each goal by facing the ball at the centerline X or O. Prior to the start of a face-off at center, one (1) player from each team shall be at the center X or O. If a player or team delays the game prior to any face-off, possession goes to the offended team.
- 7.2.2 FACE-OFF POSITIONING - The face-off players shall stand on the same side of the centerline of the floor as the goal each is defending, with their lacrosse stick resting on the floor along the centerline. Both hands and feet of each player facing off must be to the left of the throat of the stick. The hands of each face-off player must, be on the handle of the stick, must be touching the floor, and must not touch any strings. Their feet may not touch the stick.

No portion of either stick may touch. Nor may either player be in contact with their opponent's body by encroaching in the opponent's territory. The walls of the stick must be approximately eight inches apart touching the floor. The sticks must be

placed so that they are parallel to the centerline, and the players facing off must keep their feet behind the centerline. Once the players have assumed their positions, the referee shall say, "set". Players must remain motionless until the whistle is blown. Two lines shall be drawn on the turf at the center face-off position eight inches (8") apart measured from the inside edges, one half inch ($\frac{1}{2}$ ") width and six inches (6") long.

- 7.2.3 FACE-OFF VIOLATIONS - Movement by any player, facing off, after the "set" command shall cause possession to go to the opponent.

When the ball is stuck in the back of a player's stick upon facing off, possession shall be awarded to the non-offending team.

Stepping on or kicking of an opponent's stick shall be illegal and possession goes to the offended team.

When there are coincidental multiple violations (e.g. at restraining line and face-off) the face-off violation shall determine possession.

If a player gains possession on a faceoff with the ball in the reverse side of the stick, and fails to move, rake or direct it (to a teammate or themselves) and takes more than one step a faceoff violation has occurred and the ball will be awarded to the non-offending team.

- 7.2.4 CONTESTING THE BALL ON THE FACE-OFF - The two players must contest the ball when the referee blows the whistle. The ball must come out of the dotted circle. A player may not trap, clamp, or dead stick (clamp or trap and not move your stick) the ball, the opponent's stick, or the opponent's body, with the intent to withhold play inside or outside of the dotted circle. This is illegal and a technical penalty for illegal procedure shall be called. Any over-clamp, which is a stick clamping on top of the original clamp, is a violation. This is considered a technical penalty for withholding the ball from play. The ball shall be awarded to the non-offending team.
- 7.2.5 FLOOR STRENGTH BEFORE THE FACE-OFF - It is the responsibility of the referees to see that there are six players, including those in the penalty box, on each team, at the beginning of each face-off.

Rule 7.3 Positioning of All Players for the Face-Off

- 7.3.1 If a team pulls their goalkeeper and replaces the goalkeeper with another player, that player must be positioned inside their team's offensive or defensive zone.
- 7.3.2 POSITIONING PRIOR TO WHISTLE - The remaining players must take a position inside an offensive or defensive zone. Once the players have positioned themselves in an offensive or defensive zone, they must remain in those locations until the whistle sounds to start play, at which time all players are released from their respective positions. Players may be moving prior to the whistle provided they are behind the zone line and not making contact with an opponent.
- 7.3.3 CONTACT AT THE FACE-OFF CIRCLE - Players not involved in the actual face-off are allowed to enter the outside face-off circle (11' radius) while the face-off is taking place. Any player who enters the outside face-off circle (11' radius) and strikes one of the face-off participants prior to the player becoming upright in nature will be assessed the appropriate time penalty.

Rule 7.4 Facing at Other Face-Off Spots

- 7.4.1 When a face-off occurs at one of the alternate face-off spots other than at the center X or O, the position of the facing players shall be as set out in Rule 7.2 herein, except that the defending face-off player shall stand with their back to their own goal, and all other players must be at least five yards from the face-off spot.

Rule 7.5 10-Second Count

- 7.5.1 *In all situations, there shall be a ten-second (10) count half-court applicable to both teams. When a team gains possession in the defensive half of the floor, they must get the ball across the centerline within ten (10) seconds of gaining possession. Being across the centerline means both feet of a player in possession of the ball must be in the offensive half of the floor, they may not be touching the centerline or if a loose ball crosses the line.*
- 7.5.2 10-SECOND COUNT PROCEDURE - The referee shall keep the 10-second time count using a chopping motion of the hand for each second.

- 7.5.3 TIME-OUTS CALLED IN THE DEFENSIVE HALF OF THE FLOOR - In time-out situations called by either team before the expiration of the 10-second count, a new 10-second count shall be awarded after the time-out.

Rule 7.6 Backcourt Definition

- 7.6.1 Teams must keep the ball in their offensive half after gaining possession in their offensive half, or after carrying the ball across the centerline and making contact in the offensive half. Violation will result in possession awarded to the non-offending team.
- 7.6.2 BACKCOURT VIOLATION - When a loose ball or a player with possession of the ball comes in contact with the centerline of the floor for any reason other than a shot on goal or the defensive team being the last to touch the ball, it shall be a backcourt violation. If the offense was the last to touch the ball prior to the ball going into the backcourt, without a reset of the shot clock, the referee shall hold the sounding of the whistle until it is apparent that the non-offended team will not gain possession. Possession shall be awarded to the non-offending team where the ball comes to rest with the exception of immediately in front of goal. Immediately in front of the goal is deemed approximately a 10-yard radius from the center point of the top of the goalkeeper crease. The offensive team cannot intentionally direct the ball into the backcourt for any reason regardless if they are considered to have possession or not. When a goalkeeper is pulled for an extra attacker and the ball travels across center and travels into the goal, this play is regarded as a good goal.

7.6.3 BACKCOURT VIOLATION OFF A FACE-OFF - Should a player gain possession of the ball immediately after a face-off, then the ball and/or the player with possession of the ball is allowed to move towards their defensive zone. Once the player has established possession and their forward direction toward their offensive zone, the player will have committed a back court violation should the loose ball and/or the player with possession of the ball come in contact with the line immediately behind them. Behind being the next line towards the player's defensive zone.

Rule 7.7 30-Second Shot Rule

- 7.7.1 30-SECOND SHOT CLOCK RULE DEFINITION - The team in possession is required to take a shot on goal within 30 seconds of gaining possession. Failure to take a shot on goal will result in the 30-second clock timer sounding a horn and possession will go to the non-offending team. The referee shall have the authority to reset the 30-second clock to cover any unusual situation not specifically covered under these rules.
- 7.7.2 LOCATION OF CLOCK - The 30-second clock shall be located outside the playing enclosure, behind the enclosure glass, behind each goal and in view of the players and referees on the playing surface.
- 7.7.3 SHOT CLOCK RESET CRITERIA - The 30-second shot clock will reset to thirty seconds (30) when:
- The team in possession takes a shot on goal; or
 - The ball is deflected off the goalkeeper whilst the goalkeeper is in the crease; or
 - The ball deflects off a runner who is in the crease whilst the goalkeeper has been pulled and is on the bench for an extra attacker; or
 - The ball hits the goal post.

The shot clock starts when there is a team in possession. A team is in possession when cradling, holding, passing or shooting the ball in play. Team possession ends when:

- There is a shot on the goal; or
- The opponent gains possession; or
- A goal is scored or the ball goes out of bounds.

Anytime there is a floor violation or personal penalty, the 30-second shot clock is to be reset.

If a defensive player touches the ball and does not gain possession, the 30-second shot clock continues to run. If a defensive player causes the ball to go out of bounds the 30-second shot clock shall be reset.

- 7.7.4 REFEREE'S RESET SIGNAL - When it is necessary for the referee to signal the reset of the 30-second clock, the referee nearest the ball shall signal the 30-second clock operator to reset the clock. The signal shall be a whirling motion of the arm over the head.
- 7.7.5 SHOT CLOCK AND TIME-OUT CALLED - When a time-out is called, the time on the shot clock will remain, as it was when the whistle sounded to stop play. If time stops due to an injury, the clock remains, as it was when play stopped.

- 7.7.6 SHOT CLOCK MALFUNCTION - In the event one of the two 30-second clocks ceases to operate (malfunction) during play, both clocks shall be turned off until the clock problem can be resolved. The 30-second clock operator shall keep track of time and sound the horn when and if violations occur. When 10 seconds remain on the 30-second clock, this will be announced to both benches.

Rule 7.8 Out of Bounds

- 7.8.1 Play shall be suspended anytime the ball goes out of the glass enclosure (dasher boards). Possession is awarded to the team that did not touch the ball last, except for a shot on goal that deflects directly off the goalpost and goes out of bounds. In this case the offensive team will retain possession.

In all cases the ball is awarded at the position, as determined by the referee, where the ball left the playing surface. If awarded to the defensive team, the referee may award the ball to the goalkeeper in the crease area if closer.

Rule 7.9 Ball Caught in Lacrosse Stick or Equipment

- 7.9.1 BALL CAUGHT IN PLAYERS STICK OR EQUIPMENT - If the ball becomes caught in a player's equipment, other than the player's stick play shall be immediately suspended and the ball awarded to the player at that spot. If the ball becomes stuck in a player's stick, other than the goalkeeper, at any time during the game, play will be stopped immediately and possession awarded to other team.
- 7.9.2 BALL CAUGHT IN GOALKEEPERS STICK OR EQUIPMENT - If the ball becomes caught in a goalkeeper's stick, mask or other equipment following a shot, play shall be immediately suspended and possession shall be awarded to the goalkeeper and the shot clock shall be reset. If the ball becomes caught in the goalkeeper's equipment following a pass from a teammate, possession shall be awarded to the goalkeeper; however, the shot clock is not reset.
- 7.9.3 BALL CAUGHT IN STICK DURING FACE-OFF - If during a face-off the ball becomes lodged in a player's stick, the referee will stop play and award the ball to the non-offending team. This is considered a technical penalty for withholding the ball from play.

Rule 7.10 Ball Out of Sight

- 7.10.1 Should a scramble take place or a player accidentally fall on the ball, where the ball is then out of sight of the referee, the referee shall immediately blow *their* whistle and stop the play. The ball is awarded to the team who wasn't covering, "hiding" the ball. If a goalkeeper is in their crease and falls on the ball, the ball will be awarded to the goalkeeper.

Rule 7.11 Ball Striking a Referee

- 7.11.1 Play shall not be stopped if the ball touches a referee anywhere on the floor, regardless of whether a team is shorthanded or not.
- 7.11.2 BALL STRIKING REFEREE THEN OUT OF BOUNDS - When a ball deflects off a referee and goes out of play, the ensuing face-off will take place at the designated face-off spot closest to where the ball deflected off the referee.
- 7.11.3 BALL STRIKING REFEREE THEN INTO GOAL - If a goal is scored as a result of being deflected directly or indirectly into the net off a referee, the goal shall be allowed. A center face-off will restart play.

Rule 7.12 Goal Scored Definition

- 7.12.1 A goal is scored when the ball passes from the front of the goal, completely through the imaginary plane formed by the rear edges of, the goal line, the goal posts, and the crossbar of the goal, regardless of who supplied the impetus. In the event that the goal is knocked over or excessively dislodged the referee will stop play immediately.
- 7.12.2 GOAL NET INADVERTENTLY MOVED - If the goal is inadvertently moved by contact from a defensive player or goalkeeper and the offensive team is in possession and in position for a shot on goal, the referees will not stop play provided the goal has not been excessively dislodged until either the defensive team gains possession or the scoring attempt has ended. The plane of the goal does not move. It is an automatic goal providing the ball goes through the plane of the goal.
- 7.12.3 GOAL NET INTENTIONALLY MOVED - If a goalkeeper or a defensive player intentionally moves the goal to thwart a scoring opportunity, as per the Excessively Dislodged Rule, play will be stopped immediately and a penalty shot will be awarded to the non-offending team. If an offensive player intentionally moves the goal off its moorings, a minor penalty shall be assessed for unsportsmanlike conduct.

- 7.12.4 SHOT ORIGIN - A goal shall be awarded if a goal is scored when the attacker's stick head is equal to or in front of the goal-line-extended when releasing the ball during the act of shooting, provided there is no crease violation or other violation prior to the ball entering the net. The attacker's stick is permitted to make contact with the post and incidental contact with goalkeeper.
- 7.12.5 PASS FROM BEHIND GOAL LINE OFF PLAYER INTO NET - When an attacking player initiates a pass from behind the goal line and the ball strikes or rebounds off a player of either team and goes into the net, the goal will be allowed. Exception being, an attacking player, while behind the goal line, may not direct the ball into the goal by rebounding the ball off the back of the goalkeeper.
- 7.12.6 THROWING STICK OR OBJECT AT BALL OR BALL CARRIER WHEN OPPOSING GOALKEEPER HAS BEEN REMOVED - If the opposing goalkeeper has been removed and a player or returning goalkeeper throws or shoots any part of their stick or any other object at the ball or ball carrier on a breakaway, a goal shall be awarded to the attacking team.
- 7.12.7 ILLEGAL ENTRY WHEN OPPOSING GOALKEEPER HAS BEEN REMOVED - If, when the opposing goalkeeper has been removed from the floor, a player of the side attacking the unattended goal is on a breakaway and is interfered with by a player or goalkeeper who shall have entered the game illegally, the referee shall immediately award a goal to the non-offending team. "Interfered" as per this rule, does not imply physical contact by the defender.

Rule 7.13 No Goal

- 7.13.1 Under the following conditions a goal shall be disallowed:
- i) TIME EXPIRED - When the ball passes through the plane of the net after the game clock's horn or shot clock has sounded to indicate the end of a quarter or overtime period or expiration of the shot clock; or
 - ii) CREASE VIOLATION - A crease violation will result in a no goal. Crease violation is rule 8.10; or
 - iii) TOO MANY PLAYERS - When the attacking team has too many players on the floor including those in the penalty box at the time of the play; or
 - iv) AFTER REFEREE'S WHISTLE - When a referee has sounded *their* whistle for any reason, including the sounding of an inadvertent whistle; or
 - v) CONTACTS WITH GOALKEEPER - See Contact While Shooting On Net, Rule 8.12; or
 - vi) ILLEGAL STICK - When a goal is scored from a stick that is found to be illegal by a stick check done before the next live ball situation after the scoring of the goal; or
 - vii) KICKED INTO NET - When the ball is kicked in a kicking motion directly or indirectly into the opponent's goal; or
 - viii) FREE HAND INTO NET - When the ball is directed into the net off the free hand of an opponent; or
 - ix) BALL CAUGHT IN STICK THROWN INTO NET - When a ball is lodged, or not, in the pocket and the ball and stick is inadvertently or deliberately tossed into the goal; or
 - x) BALL AND GOALKEEPER PUSHED INTO NET - In the event that a goalkeeper is pushed into the net together with the ball after making the stop, the goal will be disallowed. If applicable, the appropriate penalties will be assessed; or
 - xi) DIRECTED INTO NET - If the ball is loose in the crease, by rule, a defensive player is deemed to have possession. Therefore, if the ball is loose in the crease a player may not direct the ball into the goal. Also, a no goal shall be called if an offensive player directs a loose ball in the crease, and the ball makes contact with the goalkeeper or a defender prior to the ball going into the net.
 - xii) INELIGIBLE PLAYER ON FLOOR - If a goal is scored when an ineligible player is on the floor, the goal will be disallowed. The ineligible player will be removed from the game and the club shall not be able to substitute another player on its roster. An ineligible player is a player who had been previously ejected from the game.
 - xiii) STICK HEAD BEHIND GOAL-LINE-EXTENDED - The goal will be disallowed if the attacker's stick head is behind the goal-line-extended while releasing the ball during the act of shooting.
 - xiv) STICK HEAD DISLODGED - If a player takes a shot and the head of the shooter's stick comes off and the ball enters the goal, the goal will be disallowed and the ball awarded to the goalkeeper.

Rule 7.14 Substitution

- 7.14.1 REGULAR SUBSTITUTION - Substitution of players may be made when play has been suspended by the referees:
- i) After a goal being scored; or

- ii) During a team timeout; or
- iii) During an injury timeout; or
- iv) During an referee's timeout; or
- v) During the dead ball to report a time serving penalty.

The substitute player must be properly equipped and ready to play.

7.14.2 SPECIAL SUBSTITUTION - The following special method of substitution may be used without the necessity of awaiting suspension of play by a referee in accordance with Rule 7.14.1 immediately above:

- i) During a ball out of bounds; or
- ii) A shot clock violation; or
- iii) A change of possession; or
- iv) Any technical penalty; or
- v) During the live play.

7.14.3 SPECIAL SUBSTITUTION PROCEDURE - From a team's bench area, one player at a time may enter the game by waiting for the player they are replacing to have two feet within their team's substitution area, which is marked on the floor.

The player may exit and enter at different doors or through the same door or over the boards.

The player exiting the floor has the right-of-way and substitution must be imminent. The player exiting the floor must leave the floor and enter the team bench area.

7.14.4 SUBSTITUTION OF GOALKEEPER - A goalkeeper may be changed for another player or goalkeeper at any time during a stoppage or during live play. If a substitution is made during live play it must comply with Rule 7.14.2. At no time is warm up allowed during a goalkeeper substitution. When a goalkeeper leaves their goal area and proceeds to their players' bench for the purpose of substituting another player, the referee shall be responsible to see that the substitution made is not illegal by reason of premature departure of the substitute from the bench (before the goalkeeper has entered the change area as per rule).

If the substitution is made prematurely, the referee shall stop the play immediately by blowing *their* whistle unless the non-offending team has possession of the ball, in which event, the stoppage will be delayed until the ball changes hands. A goalkeeper who maintains stationary position in the change area shall be deemed as a player on the floor. All dead ball substitutions of goalkeepers shall take no longer than 20 seconds or the offending team will receive a bench minor penalty for delay of game.

7.14.5 ILLEGAL SUBSTITUTION - Any illegal substitution shall be a bench minor penalty.

7.14.6 DELAYED PENALTY ILLEGAL SUBSTITUTION - If the defensive team is found to have too many players on the floor, a delayed penalty shall be imposed on the defensive team.

7.14.7 IMMEDIATE PENALTY ILLEGAL SUBSTITUTION - If the offensive team is found to have too many players on the floor, then the play shall be blown down and a two-minute penalty shall be imposed on the offensive team.

Rule 7.15 Criteria For Stoppage of Play on a Delayed Penalty

7.15.1 If a defending player commits a personal penalty against an opponent, whilst the non-offending team has possession of the ball, the referee shall raise *their* hand and withhold *their* whistle until such time as the completion of play by the team in possession.

"Completion of play" by the team in possession in this rule means:

- i) That the ball goes out of bounds; or
- ii) A technical violation has been committed; or
- iii) A goal is scored; or
- iv) The shot clock or game clock expire; or
- v) An offensive player commits a penalty; or

- vi) A loose ball that crosses the centerline and is rolling toward the unattended goal; or
- vii) The ball has come into possession and control of an opposing player or the ball has been "frozen".

This does not mean a rebound off a goalkeeper, the goal or the boards, or any accidental contact with the body or the equipment of an opposing player.

Rule 7.16 Injured Players

- 7.16.1 INJURED PLAYER DEFINITION - An injured player shall be defined as a player hurt requiring the referee to stop play. The injured player may not return to the floor until the next non-technical stoppage of play. Violation will result in a minor penalty to the offending player for delay of game. Should the offending team score a goal when the injured player is on the floor illegally it shall not count, provided the infraction was identified and corrected by the referee prior to the re-start of play.
- 7.16.2 INJURED GOALKEEPER - The trainer may come on to the floor to tend to the goalkeeper. If the injury is serious or 45 seconds expire commencing from the referee's acknowledgement of the injury, the goalkeeper must be replaced by a substitute without any undue delay and no warm-up shall be permitted for the substitute goalkeeper.
- 7.16.3 RETURN OF ORIGINAL GOALKEEPER - When a substitution for the injured regular goalkeeper has been made, such injured regular goalkeeper shall not resume their position until the next non-technical stoppage of play, otherwise, a bench minor penalty for illegal substitution.
- 7.16.4 PLAYER INJURED AND PENALIZED *If a penalized player has been injured, they may proceed to the dressing room without the necessity of taking a seat in the penalty box. If the injured player receives a penalty, the penalized team shall immediately put the in-home player in the penalty box and the in-home shall serve the penalty without change.*
- 7.16.5 RETURN OF INJURED AND PENALIZED PLAYER - The injured penalized player who has been replaced in the penalty box shall not be eligible to play until their penalty has expired or until such time as they would normally be released from the penalty box after serving a coincidental penalty.
- 7.16.6 STOPPAGE OF PLAY DURING A PLAYER INJURY *When a player is injured and, in the opinion of a referee:*
- the injury is serious; or*
- there is bleeding or blood evident; or*
- there is risk of further injury to the player or other players;*
- then play shall be suspended immediately.*
- Otherwise, the referee shall delay the sounding of their whistle as follows:*
- If the attacking team is in possession of the ball and, in the opinion of the referee any imminent scoring play has been completed*
- If the ball is loose, then the referee shall delay the sounding of their whistle until possession is secured and, in the opinion of the referee any imminent scoring play has been completed.*
- 7.16.7 POSSESSION ON RESTART AFTER INJURY - if play is stopped due to injury to a player, the ball will be given to the team in possession and the shot clock shall remain as it was when play stopped. If there is no possession, a faceoff will occur and on possession the shot clock will reset

SECTION 8 INFRACTIONS

SECTION 8A TECHNICAL INFRACTIONS

Rule 8.1 Possession/Technical Infractions

- 8.1.1 DELAY OF GAME - Failing to be ready for a face-off after a goal, at the start of the quarter or overtime period, or after the expiration of a time-out or after a penalty has been assessed. Any violation of the rules for positioning during a face-off is also an infraction.

- 8.1.2 PLAYING WITHOUT A STICK - If in the judgment of the referee, the loose stick represents a danger to players on the floor the referee shall immediately stop play.
- Play will resume with the team in possession retaining possession and the shot clock is not reset.
- If the ball is loose at the time play is suspended, it is faced-off at the nearest X or O spot. Players without a stick may participate in the game and may kick a loose ball.
- 8.1.3 ILLEGAL SCREEN/PICK/BLOCK - Any violation of Rule 8.2 is an illegal offensive screen/pick/block.
- 8.1.4 ILLEGAL PROCEDURE - Any action on the part of the players or substitutes of a technical nature, not in conformity with the rules and regulations governing the play of the game, shall be termed illegal procedure.
- 8.1.5 STEPPING ON A STICK - A player may not step on the stick of an opponent during a face-off, or at any other time.
- 8.1.6 TOUCHING THE BALL - A player may not touch the ball with their hand (including "thumbing the ball") during live ball. The exception applies to the goalkeeper while in the crease and the gloved hand of any player that is grasping the stick handle.
- 8.1.7 WITHHOLDING THE BALL FROM PLAY - a player shall not withhold the ball from play in any manner such as: lie on the loose ball ; or trap it with the stick longer than necessary for them to gain possession and pick it up in one continuous motion; or hold the stick against any part of their body while in possession of the ball
- 8.1.8 CREASE VIOLATIONS - See Rule 8.10, Crease Violation.
- 8.1.9 LOOSE BALL PUSH - The referee, at *their* discretion, may assess a change of possession, based on the degree of the illegal body check. A slight impediment of a player from behind on an opponent pursuing a loose ball would be an example of this.
- 8.1.10 OFFENSIVE WARD OFF - A player in possession of the ball cannot use the free arm to ward off, use their free hand or arm to control the direction or movement of an opponent, but can use the free arm to absorb contact or a blow from an opponent.
- 8.1.11 OFFENSIVE INTERFERENCE - Any minor interference by an offensive player on their opponent such as: holding of stick; or knocking the stick out of their hands. If action is severe a time served foul can be assessed

Rule 8.2 Offensive Screens/Picks/Blocks

- 8.2.1 A screen, pick, or block is legal if applied below the shoulder and above the waist, on the front, or back, or side, or on the arms of an opponent. At the discretion of the referee, screens/picks/blocks are allowed as long as forceful contact with the body, and/or excessive crosschecking during the application of the screen/pick/block is not made against an opponent. "Clutching and grabbing" is not permitted.
- Contact is expected; if contact is excessive and blatant, it shall be penalized under the appropriate rule.
- 8.2.2 OFFENSIVE SCREEN - An offensive screen is the legal action by an attacking player, attempting to impede the defensive coverage of a defender on an attacking player without possession, while looking to receive a pass. At the discretion of the referee, the player setting the screen shall be stationary or have limited mobility upon application of the screen when contact is made and may not excessively push off.
- 8.2.3 OFFENSIVE PICK - An offensive pick is the legal action by an attacking player, attempting to impede the defensive coverage of a defender on an attacking player who has possession, while looking to receive a pass.
- 8.2.4 OFFENSIVE BLOCK - An offensive block is the legal action by an attacking player, attempting to impede the defensive coverage of a defender on an attacking player with or without possession, with no intent of receiving a pass.

Rule 8.3 Handling The Ball

- 8.3.1 CHANGE OF POSSESSION - Possession shall be awarded to the non-offending team when a player or goalkeeper uses their hand to grasp, touch, or hold a ball that is outside the crease.

SECTION 8B **STICK INFRACTIONS****Rule 8.4** **Butt Ending**

- 8.4.1 Butt ending shall mean using the end of the shaft of the stick in a jabbing motion.
- 8.4.2 MAJOR PENALTY - A major penalty will be imposed on a player who attempts to make contact with a butt end on an opponent but does not make contact.
- 8.4.3 GAME MISCONDUCT - A major penalty and a game misconduct shall be imposed on a player who butt ends an opponent.
- 8.4.4 MATCH PENALTY - The referee, at *their* discretion, may assess a match penalty, if in *their* judgment the player was reckless or endangering by butt ending.

Rule 8.5 **High Sticking**

A "high stick" is when a player checks an opponent in such a way that contact is made between their stick and the opponent's neck, face or helmet. Incidental contact with the helmet should be disregarded. If a player being legally checked deliberately ducks, so as to cause the stick of the opponent to strike them on the head or neck, no penalty shall be assessed.

- 8.5.1 MAJOR PENALTY - The referee, at *their* discretion may assess a major penalty, based on the degree of violence of the check, to a player or goalkeeper who high sticks an opponent.
- 8.5.2 MATCH PENALTY - The referee, at *their* discretion, may assess a match penalty if, in *their* judgment, the player or goalkeeper was reckless or endangering their opponent by high sticking.

Rule 8.6 **Illegal Crosschecking**

- 8.6.1 A legal crosscheck shall be a check on the arms below the shoulders and above the waist rendered with both hands on the stick, on an opponent who has possession of the ball. The extension of the arms while the check is being delivered is permissible.

An illegal crosscheck shall be a check on an opponent above the shoulders, below the waist or on the back.

A defender who crosschecks a player, who is in a stationary position and not in possession of the ball shall be, assessed a penalty.

A player who uses excessive unequal pressure and force to crosscheck a non-stationary opponent not in possession of the ball, shall be assessed a penalty.

- 8.6.2 PENALTY - The referee, at *their* discretion and based on the degree of violence of the check, may assess a:
- Minor penalty; or
 - A major penalty.
- 8.6.3 MATCH PENALTY - The referee, at *their* discretion, may assess a match penalty if, in *their* judgment, the player or goalkeeper was reckless or endangering their opponent by illegal cross checking.

Rule 8.7 **Spearing**

- 8.7.1 Spearing shall mean a stabbing motion at an opponent with the head of the stick whether contact is made or not.
- 8.7.2 PENALTY - The referee, at *their* discretion and based on the degree of violence of the spear, may assess a:
- Minor penalty; or
 - A major penalty; or
 - A major penalty and a game misconduct.
- 8.7.3 MATCH PENALTY - The referee, at *their* discretion, may assess a match penalty if, in *their* judgment, the player or goalkeeper was reckless or endangering their opponent by spearing.

Rule 8.8 Throwing The Stick

- 8.8.1 NO PENALTY ASSESSED - When a player discards the broken portion of a stick by tossing it to the side of the floor, and not over the boards, in such a way as will not interfere with play or opposing player, no penalty will be imposed.
- 8.8.2 MINOR PENALTY - At the discretion of the referee a minor penalty shall be imposed on any player (offensive or defensive) on the floor who intentionally throws their stick, or any part thereof, or any other object, except when such act has been penalized by assessment of a penalty shot or the award of a goal.
- 8.8.3 PENALTY SHOT - When any member of the defending team, including anyone on the bench or penalty bench, deliberately throws or shoots any part of a stick, or any other object, at the ball or ball carrier on a breakaway or an attacker attempting to pick up a loose ball, the referee shall allow the play to be completed and if a goal is not scored, a penalty shot shall be awarded to the non-offending team. Any dressed player on the offended team may take the penalty shot.
- 8.8.4 AWARDED GOAL - If, when the opposing goalkeeper has been removed, a member of the defending team, anyone on the bench, or penalty bench, deliberately throws or shoots any part of the stick, or any other object at the ball or ball carrier having a clear shot on an "open net", a goal shall be awarded to the attacking team. An "open net" is defined as one from which a goalkeeper has been removed for an additional attacking player.
- If during a penalty shot the goalkeeper attempts to stop the penalty shot by throwing their stick or any other object a goal will be awarded.
- 8.8.5 GAME MISCONDUCT - A game misconduct penalty, at the discretion of the referee, shall be imposed on any player who intentionally throws their stick or any part thereof outside the playing area. If the offense is committed in protest of a referee's decision, a minor penalty for unsportsmanlike conduct plus a game misconduct penalty shall be assessed to the offending player.

Rule 8.9 Slashing

- 8.9.1 Slashing is the act of swinging a player's stick at an opponent without any visible attempt to dislodge the ball, whether contact is made or not. Any forceful or powerful chop with the stick on an opponent's body or stick that in the judgment of the referee is not an attempt to play the ball shall be penalized as slashing. Non-aggressive stick contact to the stick or hands of a ball carrier should not be penalized as slashing. An appropriate penalty shall be assessed to a player who slashes a non-ball carrier. A technical violation shall be assessed to any offensive player who slashes an opponent's stick and dislodges it.
- 8.9.2 PENALTY - The referee, at *their* discretion and based on the degree of violence of the slash, may assess a:
 - Minor penalty; or
 - A major penalty; or
 - A major penalty and a game misconduct.
- 8.9.3 MATCH PENALTY - The referee, at *their* discretion, may assess a match penalty if, in *their* judgment, the player or goalkeeper was reckless or endangering the opponent by slashing.

SECTION 8C CREASE INFRACTIONS**Rule 8.10 Goal-Crease Violations**

- 8.10.1 A crease infraction occurs if members of either team violate the privileges as described in rule 8D. The result of infractions can range from a technical turnover to time served penalties. The crease line is considered inside the crease.
- 8.10.2 ATTACKING PLAYER IN CREASE - An attacking player in possession of the ball, is in violation of the crease if any part of their body is on the line or inside the crease.
A player who is in contact on the crease line or in the crease with their stick only is not in violation of this rule.
- 8.10.3 ATTACKING PLAYER FIRST TOUCH/INTERFERE AFTER SHOT ON GOAL - If an attacking player by their own momentum, after taking a shot on goal or making a pass, steps into the crease and then immediately out, is not in violation of the goal crease area provided the attacking player is not the first to touch the ball and does not directly interfere with any opposing player who is attempting to pick up the ball.

- 8.10.4 **ATTACKING PLAYER IN CREASE TO GAIN ADVANTAGE** - An attacking player who is in contact in the opposing crease and exits, thereby gaining an advantage, as deemed by the discretion of the referee and makes contact with the ball or directly interferes with an opposing player who is attempting to pick up the ball is in violation and possession shall be awarded to the non-offending team.
An attacking player who is not in possession of the ball and is in contact in the opposing crease and then exits the crease, and is the first to receive a pass immediately after exiting the crease is in violation and possession shall be awarded to the non-offending team.
- 8.10.5 **ATTACKING PLAYER IN CREASE TO GAIN ADVANTAGE ON DEFENDER** - An attacking player who is in contact in the opposing crease and exits, thereby gaining an advantage, as deemed by the discretion of the referee and initiates contact on an opponent who has possession of the ball is in violation and will be assessed a delay of game minor penalty.
- 8.10.6 **NON-SHOOTER IN CREASE WHEN TEAMMATE SHOOTS** - A non-shooter who is in the opposing crease must vacate the crease by establishing body contact on the turf outside the crease with no part of the body contacting inside the crease prior to the ball crossing the plane of the goal to be an awarded goal.
- 8.10.7 **SHOOTER IN CREASE PRIOR TO BALL CROSSING GOAL LINE** - Any attacking player, who while shooting makes contact with the crease prior to the ball completely crossing the goal line, will result in no goal and possession is awarded to the non-offending team.
- 8.10.8 **CONTACT WITH GOALKEEPER** - A crease violation occurs when contact is made between the attacking player and/or their stick and goalkeeper, while the attacking player is in the crease.

It is not a crease violation when a goalkeeper reaches out with their stick and makes contact with an attacker who is in the crease.

The attacking player is in violation of the crease when that attacking player, while in the crease makes contact with a defender, and as a result the defender then makes contact with the goalkeeper.

Incidental contact, at the discretion of the referee, by an attacker who is in the act of shooting on a goalkeeper and makes contact with their body or stick, which in no way affects the ability of the goalkeeper to attempt to make a save or play on the ball shall not result in a crease violation provided the ball enters the goal. If the ball does not enter the goal from the attacker shooting and contact is made within the crease between the goalkeeper and the shooter, play will be blown down immediately and possession awarded to the non-offending team.

At the discretion of the referee, the attacker and goalkeeper may be subject to a penalty as per rule 8.12, "Contact on goalkeeper initiated by attacker and contact initiated by goalkeeper".

An attacking player who makes incidental contact with the goal posts and or mesh shall not constitute a crease violation. Also, refer to Displacement of Goal, rule 8.36.

- 8.10.9 **ATTACKER AND BALL IN CREASE** - A crease violation occurs when an attacker is in the crease, at the same time as the ball, and inhibits and/or interferes with the goalkeeper's attempt to retrieve the ball, resume play and/or perform normal duties of play. Play shall be stopped immediately and possession awarded to the non-offending team.

Should the attacker be in the crease, at the same time as the ball, and in no way affects the goalkeeper to perform normal duties of play, play shall continue with no crease violation, however should a goal be scored in this scenario it would be disallowed, see rules 7.13.1 & 8.10.10.

- 8.10.10 **CONTACT BY A DEFENDER** - A crease violation occurs when any offensive player is in the crease when a goal is scored, except when the attacker has been illegally checked by a defender.
- 8.10.11 **GOALKEEPER HAND BALL** - A goalkeeper may catch the ball while in their crease (deemed two feet in their crease) with the gloved hand but cannot throw the ball with their hand; the goalkeeper can only put the ball in the stick with their hand and throw with the stick. If the goalkeeper throws the ball with their hand, possession shall be awarded to non-offending team. A goalkeeper is permitted to use their hand to drop the ball into a teammates stick within the crease only. A goalkeeper cannot use their hand to grasp, touch or hold the ball outside their crease. A violation results in possession to the non-offending team.

- 8.10.12 NO RE-ENTRY BY PLAYER - It is a violation for a player or the goalkeeper, while in possession of the ball, to enter the goal crease area.
- Nor may he remain in the goal crease area in possession of the ball for longer than four (4) seconds.
- 8.10.13 NO REENTRY BY BALL - A goalkeeper or a defending player in the crease is not allowed to make contact with a ball that has been deliberately directed or passed back to the crease by a teammate. This would include a ball after being deliberately directed hits the dasher board and then enters crease or a ball that is deliberately directed that rolls through the crease and a goalkeeper or a defending player in the crease then makes contact with the ball. If a deliberately directed ball is deflected by an offensive player this will not be considered reentry. A defender while in the crease is allowed to pick up a non-deliberately directed loose ball outside the crease.
- 8.10.14 CHECKING A NON-GOALKEEPER WHO HAS POSSESSION IN THE CREASE - When a defending player other than the goalkeeper is in their own crease with possession, opposing players may not enter the crease to body-check said player.
- Opposing players may check the stick of the ball carrier when said player has two feet in the crease and the ball and stick is outside the crease
- Opposing players may attempt to intercept a pass by said player and stick-on-stick contact is allowed outside the crease. Violation of this rule shall result in a two (2) minute minor penalty or more serious penalties if warranted.
- 8.10.15 BALL ENSNARED IN NETTING - Should the ball be continuously contacting or resting on the back of the netting (ensnared), the referee shall stop play and the ball is given to the goalkeeper in their crease.
- 8.10.16 PENALTY SHOT - Should a player in their own end deliberately fall on the ball in their crease in front of their goal line, or deliberately closes their hand on the ball in the crease in front of their goal line, a penalty shot will be imposed on the offending team. See rule 6.9.6

SECTION 8D GOALKEEPER PRIVILEGES

Rule 8.11 Goalkeeper Privileges

- 8.11.1 *The privileges of the goalkeeper are intended to protect the goalkeeper from injury and afford them the opportunity to perform the functions of a goalkeeper without interference by an opponent. Violation of this rule will result in a penalty ranging from a change of possession up to awarding of a penalty shot. Only a designated goalkeeper as recorded in the official scorebook/game sheet has the privileges of the goalkeeper and crease area. Should there be six (6) players from the same team on the floor (outside of the crease) without a designated goalkeeper, then no one has the privileges of the goal, goalkeeper and/or the crease. Within their own goal crease area, the designated goalkeeper may stop or block the ball in any manner with their lacrosse stick or body. They may block, catch, pickup, or bat the ball away with their hand. The goalkeeper or defending player after gaining control of the ball has four (4) seconds to either pass the ball or vacate the crease. When a goalkeeper leaves the goal crease area they lose all goalkeeper privileges and protection of the crease. Should the goalkeeper proceed up the floor with the ball, They may be checked like any other player. However, they cannot be "charged" or "slashed", or unnecessarily roughed up.*
- 8.11.2 *CONTACT WITH GOALKEEPER IN THE CREASE - If the goalkeeper has two feet in the crease and possession of the ball in their stick and both stick and ball are outside of the crease, they may not be checked*
- If a defender makes contact with the goalkeeper's stick while the goalkeeper still has possession of the ball during an outlet pass, while the goalkeeper is in their crease (deemed two feet in their crease), the defender will receive a minor penalty for goalkeeper interference*
- If the ball is clamped outside the crease circle by the goalkeeper, a player may rake under the goalkeeper's stick.*

Rule 8.12 Contact While Shooting on Net

- 8.12.1 CONTACT ON GOALKEEPER INITIATED BY ATTACKER - If an attacking player in the act of diving, or jumping into the crease, physically initiates contact with the goalkeeper and the ball enters the goal, the goal will be disallowed and an appropriate penalty to the attacker will be assessed.

Incidental contact by an attacker in the act of shooting on a goalkeeper with the body or stick, which in no way affects the ability of the goalkeeper to attempt to make a save or play the ball shall not be penalized.

8.12.2 PENALTY - The referee, at their discretion and based on the degree of the infraction, may assess a:

- Minor penalty; or
- A major penalty; or
- A major penalty and a game misconduct; or
- A match penalty.

8.12.3 CONTACT INITIATED BY GOALKEEPER - If a player of the attacking side is physically interfered with by contact solely initiated by the goalkeeper, the attacker shall not receive a penalty for goalkeeper interference. The goalkeeper may be subject to a penalty. Should the ball enter the net after this contact has been made, provided there is no crease violation, the goal shall be allowed.

8.12.4 TIME AND DISTANCE BETWEEN SHOT AND CONTACT ON GOALKEEPER INITIATED BY ATTACKER - If a legal shot is taken and the ball enters the net and the shooter then enters the crease and contacts the goalkeeper, the goal shall be awarded, provided the goalkeeper has time and distance to play the shot, the ball enters the goal long before the contact is made, and the ball enters the goal before the shooter enters the crease. A penalty to the attacker can be assessed if avoidable contact is made.

8.12.5 CONTACT INITIATED BY DEFENDER ON ATTACKER INTO THE CREASE - If a player of the attacking side is illegally interfered with by the action of a defending player so as to cause them to be in the goal crease and the ball should enter the net while the player so interfered with is still in the goal crease, the goal shall be allowed.

A defender, who illegally interferes with an attacker while the attacker is in the act of diving or jumping into the crease, resulting in contact on the goalkeeper solely because of the defenders actions, the defender shall be assessed appropriate penalties and the goal shall count.

At the discretion of the referee, if the attacking player is fouled causing them to be in the crease and the attacking player does not use their best efforts to immediately vacate the crease, and a goal was scored, the goal shall not be allowed.

8.12.6 AVOIDABLE CONTACT BY ATTACKER ON GOALKEEPER - A penalty shall be assessed to a player of the attacking side who, having been interfered with, fails to avoid making contact with the goalkeeper.

Unavoidable contact by the attacker will not be penalized.

8E Restraining Infractions

Body position shall play an important role in determination of restraining violations. Body position shall be determined as the player in front of or beside an opponent traveling in the same direction. A player who is behind an opponent may not use their free hand or body, to restrain an opponent but must run in order to regain and establish their proper position in order to make a check. Once body position is established, the defender may use their arms and hands in only a pushing motion within the distance between their shoulders. The referee may assess a possession change or served penalties as per below.

The use of a body check is legal with one hand on the stick, provided the contact is below the shoulders or above the waist and there is no forcible thrust of the player's stick.

Rule 8.13 Illegal Body Checking

- 8.13.1 *It is illegal to body check an opponent from behind, above the shoulders or below the waist. It is legal to body-check an opponent in possession of the ball from the front or side, above the waist and below the shoulder. It is legal to body check an opponent while the player leaves their feet to shoot, pass or catch the ball or otherwise engage legally in offensive play provided contact is legal as outlined above, and there are no other violations and the check is not into the boards. Officials shall consider positioning of players when contact is initiated, specifically whether the player being checked is in a vulnerable and defenseless position, which many include a players' head being down or unaware of an impending hit, significant distance travelled by the player making the hit. An appropriate penalty for illegal body checking shall be assessed based on the severity of the illegal contact.*
- 8.13.2 CONTACT WHILE PURSUING A LOOSE BALL - When two players are pursuing a loose ball, checking the opponent's stick and body contact is allowed within three (3) yards of the loose ball.
- Also, the player may initiate contact with an opponent who is in possession of the ball or who is within three (3) yards of a loose ball with either a closed gloved hand on the handle of their stick or either forearm. Both gloved hands need not be on the player's stick when in the act of initiating contact with an opponent.
- 8.13.3 EQUAL PRESSURE - A defending player may impede the progress of an attacking non-ball carrier who is not in contention for a loose ball or receiving a pass provided he uses an "equal pressure" motion with their body and stick on the front or side of the opponent on the arms.
- 8.13.4 CONTACT AFTER PASS OR SHOT - The avoidable body-checking of an opponent, including the goalkeeper, of more than two steps after the opponent has passed the ball to a teammate or taken a shot at the goal, is not allowed.
- 8.13.5 *CONTACT ON A FAST BREAKING OPPONENT - A goalkeeper or player must give a fast breaking opponent the opportunity to take one step to gain composure after receiving the ball, before body contact is allowable. Officials shall consider positioning of players when contact is initiated, specifically whether the player being checked is not in a vulnerable or defenseless position, which many include a players' head being down or unaware of an impending hit, significant distance travelled by the player making the hit. An appropriate penalty for illegal body checking shall be assessed based on the severity of the illegal contact.*
- 8.13.6 CONTACT INITIATED BY A GOALKEEPER IN THE CREASE - A goalkeeper may not use their crease to their advantage to deliver a body check to an opponent.
- 8.13.7 PENALTY - The referee, at *their* discretion and based on the degree of the illegal body check, may assess a:
- Minor penalty; or
 - A major penalty; or
 - A major penalty and a game misconduct.
- 8.13.8 MATCH PENALTY - The referee, at *their* discretion, may assess a match penalty if, in *their* judgment, the player attempted to or deliberately injured an opponent by an illegal body check.

Rule 8.14 Holding

- 8.14.1 Any player who impedes the progress of any player by using their arms, legs, or hands (with or without the ball). Body position, as outlined above, shall apply in assessing all holding infractions.

- 8.14.2 FREE HAND - A player checking with one hand on their stick may only make “stick-on-stick” contact on an opponent. Contact made with the off-hand that restrains the opposing player in this situation is not allowed and a minor penalty will be assessed.
- 8.14.3 HOLDING AN OPPONENT’S STICK - A player is not permitted to hold an opponent’s stick.
- 8.14.4 MINOR PENALTY - The referee shall assess a minor penalty to a player who holds an opponent.
- 8.14.5 PENALTY SHOT – When a player is on a breakaway and is held from behind, thus preventing a reasonable scoring opportunity, a penalty shot shall be awarded to the non-offending team.

Rule 8.15 Hooking

- 8.15.1 Hooking is the act of using the stick in a manner that enables a player to restrain an opponent.

When a player is checking another player in such a way that there is only stick-to-stick contact, such action is not to be penalized as hooking.

- 8.15.2 PENALTY - The referee, at *their* discretion and based on the degree of the hook, may assess a:
- Minor penalty; or
 - A major penalty.

Rule 8.16 Interference by/With Spectators

- 8.16.1 SPECTATOR ON THE FLOOR - In the event of a player being held or interfered with by a spectator, the referee shall blow the whistle and stop the play unless the team of the player interfered with is in possession of the ball. Allow the play to be completed before blowing the whistle and then award the ball, at the restraining line, to the team who was in possession when the interference occurred.
- 8.16.2 OBJECTS THROWN ON FLOOR - In the event that spectators throw objects on the floor, and they interfere with the progress of the game, the referee shall blow the whistle, stop the play and the ball will be awarded to the team in possession.

In the event that objects are thrown on the floor during the process of the game or during the stoppage of play, including after the scoring of a goal, a bench minor penalty will be assessed to the home team.

This rule is not meant to penalize the celebration of certain milestones. A warning via the public address system must first be given before assessing this penalty.

SECTION 8E PHYSICAL INFRACTIONS**Rule 8.17 Boarding**

8.17.1 A boarding penalty shall be assessed on any player who checks an opponent in such a manner that causes the opponent to be thrown violently into the boards. The onus is on the player who is applying the check to ensure their opponent is not in a vulnerable position and if so, must avoid contact.

However, there is also the onus on the other player not to put themselves in a dangerous position. The referees when applying this rule must consider this balance.

8.17.2 PENALTIES - The referee, at *their* discretion and based on the degree of the impact into the boards, may assess a:

- Minor penalty; or
- A major penalty; or
- A major penalty and a game misconduct.

The referee, at *their* discretion, may assess a match penalty if, in *their* judgment, the player or goalkeeper was reckless or endangered an opponent by boarding.

Rule 8.18 Spearing With Your Head

8.18.1 Spearing with your head is the action of a player leading with the head to make contact or attempt to make contact on another player. A player, in possession of the ball, who lowers their shoulder in order to get past or through an opponent and makes unintentional contact with their head shall not be penalized. The referee shall have the latitude to determine the intent of the action of the player.

8.18.2 PENALTIES - The referee, at *their* discretion and based on the degree of violence of the spearing with the head, may assess a:

- Minor penalty; or
- A major penalty; or
- A major penalty and a game misconduct.

The referee, at *their* discretion, may assess a match penalty if, in *their* judgment, the player or goalkeeper was reckless or endangered an opponent by spearing with the head.

Rule 8.19 Checking From Behind

8.19.1 A check from behind is a check made on the back of the body. When a player intentionally turns their body to create contact with their back, no penalty shall be assessed.

8.19.2 PENALTIES - The referee, at *their* discretion and based on the degree of violence of the check from behind, may assess a:

- Minor penalty; or
- A major penalty; or
- A major penalty and a game misconduct.

The referee, at *their* discretion, may assess a match penalty if, in *their* judgment, the player or goalkeeper was reckless or endangered an opponent by checking from behind.

Rule 8.20 Dangerous Contact to the Head

8.20.1 *MATCH PENALTY A match penalty shall be assessed to a player who with force strikes another player directly in the head and/or neck. The actions of the player shall be deemed as reckless. Criteria for this penalty shall include some of the following but is not limited to:*

- no attempt to play the ball; or
- Leaving your feet to inflict more force; or
- An upwards motion as opposed to a horizontal motion.

Rule 8.21 Elbowing

8.21.1 Elbowing shall mean the use of an extended elbow in a manner that may or may not cause injury.

8.21.2 PENALTIES - The referee, at *their* discretion and based on the degree of violence of the elbowing, may assess a:

- Minor penalty; or
- A major penalty; or
- A major penalty and a game misconduct.

The referee, at *their* discretion, may assess a match penalty if, in *their* judgment, the player or goalkeeper was reckless or endangered an opponent by elbowing.

Rule 8.22 Face Masking

8.22.1 Any player who grabs the facemask of an opponent is guilty of face masking.

8.22.2 PENALTIES - The referee, at *their* discretion and based on the degree of violence of the face-masking, may assess a:

- Minor penalty; or
- A major penalty; or
- A major penalty and a game misconduct.

The referee, at *their* discretion, may assess a match penalty if, in *their* judgment, the player or goalkeeper was reckless or endangered an opponent by face masking.

Rule 8.23 Fighting

8.23.1 FIGHTING - A fight is an incident where at least one player is penalized for throwing a punch, punches, or blows at an opposing player. The punches do not necessarily need to make contact. Referees have the discretion to assess minor penalties for roughing (see roughing rule) or a major penalty for fighting, along with any other appropriate penalties, based on the degree of violence of the punches or blows thrown at an opposing player.

The referee is provided very wide latitude in the penalties, which *they* may impose under this rule. This is done intentionally to enable them to differentiate between the obvious degrees of responsibility of the participants either for starting the fighting or persisting in continuing the fighting. The discretion provided should be exercised realistically.

Referees are directed to employ every means provided by these rules to stop "brawling".

Unwilling combatant: For definition purposes an "unwilling combatant" is a player who attempts to defend themselves against their opponent by protecting themselves from incoming blows and or punches. The unwilling combatant will use their best efforts to deflect any incoming blows or punches. The unwilling combatant criteria will include not dropping their gloves, not taking their helmet off on their own accord, or any other actions that would constitute the player deemed willing to engage in the fight. Also, the unwilling combatant does not initially counter with any return punches or blows. The unwilling combatant may be subject to appropriate penalties, if any, for their actions.

8.23.2 FIGHTING PENALTY ASSESSMENT - A player deemed to be fighting shall be assessed:

- A 5-minute major and a game misconduct, for fighting; and
- An automatic one game suspension from the team's next game.

8.23.3 INSTIGATOR - An instigator of a fight shall be a player who by their actions or demeanor demonstrates at least one of the following criteria:

- Distance traveled in order to begin fighting; or
- Gloves off first; or
- First punch thrown; or
- Substitution direct from bench in order to begin fight; or
- Menacing attitude or posture;

- Verbally inciting another player: or
- Gestures or threats; or
- Conduct in retaliation to a prior game incident.

Note: Not all fights will have a clear instigator. An instigator penalty should be assessed when the referee is certain the offending player has committed at least one of the defined criteria.

- 8.23.4 INSTIGATOR PENALTY ASSESSMENT - A player who is deemed to be the instigator of a fight shall be assessed the fighting penalties plus the instigator penalties, all of which are:
- A 5-minute major and a game misconduct, for fighting; and
 - A 5-minute major and a game misconduct, for instigator; and
 - A game misconduct for two (2) major penalties; and
 - An automatic one game suspension from the team's next game.
 - AGGRESSOR - A player who is an outright aggressor of a fight is a player who continues to fight after the referees have attempted to separate fighters, or attempts to restart a fight, or refuses to stop fighting after being so instructed.
- 8.23.5 AGGRESSOR PENALTY ASSESSMENT - A player who is deemed to be the aggressor of a fight shall be assessed the fighting penalties plus the aggressor penalties, all of which are:
- A 5-minute major and a game misconduct, for fighting; and
 - A 5-minute major and a game misconduct, for aggressor; and
 - A game misconduct for two (2) major penalties; and
 - An automatic one game suspension from the team's next game.
- 8.23.6 PENALTY IF BOTH INSTIGATOR AND AGGRESSOR - A player who is deemed to be both the instigator and an aggressor of a fight shall be assessed the fighting penalties plus the instigator penalties plus the aggressor penalties, all of which are:
- A 5-minute major and a game misconduct, for fighting; and
 - A 5-minute major and a game misconduct, for instigator; and
 - A 5-minute major and a game misconduct, for aggressor; and
 - A game misconduct for two (2) major penalties; and
 - An automatic one game suspension from the team's next game
- 8.23.7 UNWILLING- COMBATANT - If player has been defined by rule as an unwilling combatant they are not to receive a fighting penalty but may be subject to other penalty types.
- 8.23.8 INSTIGATOR WITH FACEMASK ON - Any player who instigates a fight with a facemask on against an opponent who already has their facemask off will be deemed an instigator.
- 8.23.9 SWEATER REMOVAL DURING A FIGHT - A player who deliberately removes their sweater prior to participating in a fight, or a player who engages in a fight and whose sweater is removed (completely off their torso), other than through the actions of their opponent in the fight or through the actions of the referee, shall be assessed a minor unsportsmanlike penalty
- 8.23.10 EQUIPMENT REMOVAL PRIOR TO OR DURING A FIGHT PENALTY ASSESSMENT A player who removes their equipment prior to or during a fight on their own accord shall be assessed a minor penalty for unsportsmanlike conduct. Any combination of the jersey removal and equipment removal will result in one minor penalty being assessed. This is not to include helmet or gloves.
- This is in addition to other penalties to be assessed to the participants of a fight.
- 8.23.11 RETALIATION AFTER BEING STRUCK - A minor penalty shall be imposed on a player who, having been struck, shall retaliate with a blow, or attempted blow.

However, at the discretion of the referee, a major, or major and a game misconduct penalty may be imposed if such player continues their fight.

- 8.23.12 TAPE ON HANDS - Any player wearing tape or any other material on their knuckles or fingers that cut or injure an opponent during a fight will receive a match penalty. This is in addition to penalties assessed for fighting.
- 8.23.13 FIGHT OFF THE PLAYING FLOOR - A game misconduct penalty shall be imposed on any player involved in a fight off the playing floor or with another player who is off the floor. This penalty is in addition to any other time penalties assessed.
- 8.23.14 INTERVENTION IN A FIGHT ALREADY IN PROGRESS - A game misconduct penalty shall be imposed on any player or goalkeeper who, at the discretion of the referee, is first to intervene in a fight already in progress, except when a match penalty is being imposed in the original fight. This penalty is in addition to any other penalty incurred in the same incident.

Any player who is in violation of this section will be automatically suspended for their team's next game.

- 8.23.15 GOALKEEPER LEAVING THEIR CREASE DURING A FIGHT - During a fight, goalkeepers must remain in their crease. If a goalkeeper leaves the crease during a fight they will be assessed a minor penalty. If they get involved in a fight they will be assessed a major and a game misconduct.
- 8.23.16 NON-FIGHTING PLAYERS FLOOR POSITIONING - When a fight occurs, all players not engaged shall go immediately to their players' bench and in the event the fight takes place at their players' bench, players on the floor from their team shall go to their defensive end, as directed by the referees' instructions. A misconduct penalty shall be assessed to any player who is in violation.
- 8.23.17 SECOND FIGHT AFTER THE ORIGINAL FIGHT - A match penalty shall be imposed on a player who is assessed a major penalty for fighting after the original fight.
- 8.23.18 NON-PLAYER STRIKING AN OPPONENT - Any Club Executive, Manager, Coach or team staff who holds or strikes an opponent, shall be automatically suspended from the game, ordered to the dressing room. A bench minor will be assessed against the offending team and the Head Referee shall report the incident on the game sheet or special incident report.

Rule 8.24 Head Butting

- 8.24.1 Head butting is the action of a player using their head to attempt to or make contact on another player. A player, who is in possession of the ball and lowers their shoulder in order to get past or through an opponent and makes unintentional contact with their head, shall not be penalized.
- 8.24.2 MINOR PENALTY - A minor penalty shall be imposed on a player who attempts to head-butt an opponent, without any contact.
- 8.24.3 MAJOR PENALTY - A major penalty shall be imposed on a player who head-butts an opponent with their helmet on based on the severity.
- 8.24.4 GAME MISCONDUCT - A major and a game misconduct penalty may be imposed on a player who head-butts an opponent with their helmet on based on the severity.
- 8.24.5 MATCH PENALTY - A match penalty shall be imposed on a player who head-butts an opponent with or without their helmet based on the severity.

Rule 8.25 Intentional Contact During Dead Ball Situations

- 8.25.1 The referee, at *their* discretion, shall assess a penalty to any player who intentionally makes contact with another player after the whistle has blown and during dead ball situations.
- 8.25.2 PENALTIES - The referee, at *their* discretion and based on the degree of violence of the intentional contact by the player during dead ball situations, may assess a:
- Minor penalty; or
 - A major penalty; or
 - A major penalty and a game misconduct.

The referee, at *their* discretion, may assess a match penalty if, in *their* judgment, the player or goalkeeper was reckless or endangered an opponent by intentional contact during dead ball situations.

Rule 8.26 Kneeing

- 8.26.1 Kneeing is the act of a player leading with their knee and/or lower leg to make contact with an opponent.

8.26.2 PENALTIES - The referee, at *their* discretion and based on the severity of the infraction to the player guilty of kneeling an opponent, may assess a:

- Minor penalty; or
- A major penalty; or
- A major penalty and a game misconduct.

The referee, at *their* discretion, based on the severity of the infraction, may assess a match penalty to a player who was reckless or endangered their opponent by kneeling.

Rule 8.27 Kicking a Player

8.27.1 It is a violation for a player to deliberately use their foot with a kicking motion to make contact with an opponent.

8.27.2 PENALTIES - The referee, at *their* discretion and based on the severity of the infraction of the player kicking an opponent, may assess a:

- Minor penalty; or
- A major penalty; or
- A major penalty and a game misconduct.

The referee, at *their* discretion, based on the severity of the infraction, may assess a match penalty to a player who was reckless or endangered an opponent by kicking the opponent.

Rule 8.28 Roughing

8.28.1 Shall be defined as any excessively violent holding, pushing or punching motion with or without the glove on.

Any deliberate or excessively violent contact or crosscheck by a defensive player against an offensive player who has established a legal screen/pick position.

Any avoidable act using ones body or stick, which is deliberate or excessively violent.

8.28.2 PENALTIES - The referee, at *their* discretion and based on the severity of the infraction of roughing an opponent, may assess a:

- Minor penalty; or
- A double minor penalty; or
- A major penalty; or
- A major penalty and a game misconduct.

The referee, at *their* discretion, based on the severity of the infraction, may assess a match penalty to a player who was reckless or endangered an opponent by roughing.

Rule 8.29 Tripping

8.29.1 Shall be defined as any player who intentionally places their stick or any portion of their body in such manner that will cause an opponent to trip. Should the player be tripped and not completely fall down, an appropriate penalty shall still be assessed.

8.29.2 MINOR PENALTY - The referee, at *their* discretion, shall assess a minor penalty on a player who intentionally places their stick or any portion of their body in such a manner that will cause their opponent to trip.

8.29.3 PENALTY SHOT - When a player is on a breakaway and is tripped or otherwise fouled from behind, thus preventing a reasonable scoring opportunity, a penalty shot shall be awarded to the non-offending team. Nevertheless, the referee shall not stop play until the attacking side has lost possession of the ball to the defending side. The intention of this rule is to restore a reasonable scoring opportunity, which has been lost by reason of a foul from behind.

8.29.4 AWARDED GOAL - A goal shall be awarded to the attacking team when, with the opposing goalkeeper removed, a defensive player trips or otherwise fouls a player on a breakaway, thus denying the attacker a reasonable scoring opportunity.

Rule 8.30 Abuse of Officials

- 8.30.1 The referee at their discretion, may assess an abuse of officials penalty if, in their judgment, a player:
- Deliberately applies physical force in any manner against a referee or a minor official; or
 - In any manner attempts to injure a referee or minor official; or
 - Physically demeans a referee or minor official; or
 - Deliberately applies physical force to a referee or minor official solely for purpose of getting free of such official during or immediately following an altercation for the purpose of returning to or engaging in another altercation.
- 8.30.2 GROSS MISCONDUCT Any player assessed a physical abuse of Officials penalty for making deliberate contact with a referee will be reviewed by the NGB to determine the appropriate discipline for this type of severe penalty. This situation is serious and should at a minimum be considered for suspension.
- 8.30.3 GROSS MISCONDUCT Any Club Executive, manager, Coach or Team Staff (non-player) a physical abuse of Officials penalty for making deliberate contact with a referee will be reviewed by the NGB to determine the appropriate discipline for this type of severe penalty. This situation is serious and should at a minimum be considered for suspension.

SECTION 8F EQUIPMENT INFRACTIONS**Rule 8.31 Equipment Inspection**

- 8.31.1 RANDOM EQUIPMENT INSPECTION - A referee may conduct random equipment inspections before, or during the game.
- 8.31.2 PREGAME INSPECTION PROCEDURE - During the pregame inspection, goalkeepers will be measured without their jersey and shall have no tape or any other device that would result in a retraction of equipment for the intent to meet specifications. Application of tape after the measurement is permissible provided it is not deemed as bulk being added and results in no other violations.
- 8.31.3 EQUIPMENT INSPECTION LIST - All players will be required to conform to the uniform standards. The following items shall be inspected when the referees conduct a random equipment check:
- i) Helmet, facemask, and chinstrap; and
 - ii) Gloves; and
 - iii) Shoulder/vest and rib pads; and
 - iv) Goalkeeper pants and pads; and
 - v) Goalkeeper shin pads; and
 - vi) Mouth guard, (intra oral mouthpiece); and
 - vii) Any other equipment worn by the player.

It is recommended that arm pads, elbow pads, kneepads and athletic support be worn.

- 8.31.4 INSPECTION REQUESTS BY COACHES DURING GAME FOR GOALKEEPERS ONLY - Opposing coaches may request the referees to conduct a measurement and contour equipment goalkeeper inspection during the game. Upon said request, which must be made prior to the conclusion of the quarter, the referees shall conduct the inspection immediately following the conclusion of the quarter in which the request was made. The referee, as per rule 5.7, "Goalkeeper Equipment", shall check all pieces of equipment.
- Should a request be made and the requested goalkeeper is to be replaced by a substitute goalkeeper, play will be stopped followed by the inspection at that time. Only one goalkeeper shall be measured per stoppage per team.
- 8.31.5 PRE GAME INSPECTION ILLEGAL GOALKEEPER EQUIPMENT - If an inspection conducted before the game finds the goalkeeper to be using illegal equipment (failure to meet measurement and contour specifications) the goalkeeper will:
- i) Be reported to the league or appropriate sport governing body; and
 - ii) Must be deemed legal by the referees before entering in the game.
- 8.31.6 DURING/AFTER GAME INSPECTION ILLEGAL GOALKEEPER EQUIPMENT - If an inspection conducted during the game or after the game finds the goalkeeper to be using illegal equipment, (failure to meet measurement and contour specifications) the referee will assess the goalkeeper a two-minute penalty and a game-misconduct and the incident shall be reported to the league or the appropriate sport governing body.
- 8.31.7 GOALKEEPER ADJUSTING EQUIPMENT BEFORE INSPECTION - Should a goalkeeper adjust their equipment in an effort to retract the size or shape of their equipment after a referee has announced the requested inspection, the player will receive a two-minute penalty and a game misconduct.
- 8.31.8 DURING GAME GOALKEEPER INSPECTION LEGAL GOALKEEPER EQUIPMENT - If an inspection conducted during the game finds the goalkeeper to have used legal equipment, the referee will assess a 2-minute bench minor penalty, delay of game, to the requesting team.

Rule 8.32 Broken Stick

- 8.32.1 A broken stick is one, which in the opinion of the referee is unfit for normal play. A player without a stick may participate in the game. A player whose stick is broken may participate in the game provided they drop the stick. The player may be handed one from a teammate on the floor or receive a stick at their bench.

- 8.32.2 GOALKEEPER PLAYING WITH A BROKEN STICK - A goalkeeper may continue to play with a broken stick until a stoppage of play or until they have been legally provided a stick.
- 8.32.3 MINOR PENALTY - A minor penalty shall be imposed for any player who continues to play with a broken stick.

Rule 8.33 Equipment or Clothing Adjustment

- 8.33.1 The onus of maintaining clothing and equipment in proper condition shall be upon the player. The player shall leave the floor and play shall continue with a substitute. Play shall not be stopped nor the game delayed by reasons of adjustments to clothing, equipment or sticks.

MINOR PENALTY - A minor penalty shall be assessed to a player who, having been notified by a referee of improper condition of equipment, fails to remove themselves from the floor thus preventing the restart of play.

Rule 8.34 Helmet Lost During Play

- 8.34.1 When a player loses their helmet, the player must immediately re-assemble and put on their helmet or leave the floor.
- When a player in possession of the ball loses their helmet they must immediately release the ball by passing or shooting.
- 8.34.2 MINOR PENALTY - Failure to immediately re-assemble the helmet and wear it, or leave the floor shall result in a minor penalty to the offending player.

SECTION 8G OTHER INFRACTIONS**Rule 8.35 Delaying The Game**

8.35.1 All violations under this rule shall have resulted in a player's action causing a delay of the game, such as on any quick restart (i.e. shot clock violation, crease violation, etc.).

8.35.2 DELIBERATELY SHOOTS BALL OUT OF BOUNDS - The referee, at *their* discretion, may assess a minor penalty, if in *their* judgment, the player or goalkeeper delays the game by deliberately shooting, hitting, or batting the ball outside the playing area.

When the goalkeeper deliberately shoots the ball directly (non-deflected) out of the playing surface, except where there is no glass, a penalty shall be assessed for delay of game. A ball shot during play that hits any infrastructure above the playing surface that is inside the glass around the arena, shall result in a possession, not a penalty.

8.35.3 THROWS, RETAINS OR ROLLS BALL AWAY - A minor penalty shall be imposed on any player or goalkeeper who throws, retains or rolls the ball away that results in a delay of game. This shall include any action by a player that disrupts the restart of the game such as holding onto the ball, or tossing the ball to the referee, rather than immediately putting the ball down directly upon expiry of loss of possession inhibiting a fast restart for the opposing team.

8.35.4 THROWS BALL AWAY FOR STALLING PURPOSES - Teams shall not deliberately throw the ball down to their defensive zone with time remaining in the 30-second clock strictly for "stalling" purposes to allow their defensive unit on the floor. A bench minor penalty will be assessed to the offending team.

8.35.5 FAILING TO COMPLY WITH PLACING CORRECT NUMBER OF PLAYERS ON FLOOR - A bench minor penalty shall be imposed upon any team which, after warning by the referee to place the correct number of players on the floor and commence play, fails to comply with the referee's direction and thereby causes any delay by making additional substitutions.

8.35.6 NO TIME-OUTS REMAINING - In the event a team that does not possess any more time-outs calls a time-out they will be assessed a two-minute delay of game, and the other team is awarded possession of the ball (also see Rule 2.6).

8.35.7 NON-PLAYING PERSONNEL ON BENCH - No one but players in uniform, the Head Coach, and five non-playing personnel shall be permitted to occupy the benches so provided.

The Head Referee will instruct the Head Coach to order the removal of any offending individuals from the player's benches. After such warning, if the individual does not leave, or returns to the team bench, a bench minor penalty will be imposed on the offending team.

8.35.8 LATE COMMENCEMENT OF PLAY - The teams shall be on the floor at the appointed time for the beginning of the game and commencement of each quarter. A violation of this rule shall result in a delay of game and a minor penalty to the offending team.

8.35.9 GOALKEEPER EQUIPMENT REPAIR TIME LIMITATION - In the event the goalkeeper loses protective equipment which cannot be repaired within 30-seconds, the goalkeeper must exit the floor.

If the goalkeeper equipment takes more than 30-seconds to repair, the goalkeeper must be removed from the game and the substitute goalkeeper must be prepared to play in no longer than 20 seconds or a bench minor penalty will be assessed.

8.35.10 FAILURE TO CLOSE SUBSTITUTION DOORS - The Head Referee will inform team personnel that the substitution doors cannot be left open. If after such warning the team does not comply, a bench minor penalty will be imposed on the offending team.

8.35.11 DEBRIS ON PLAYING SURFACE - If the floor becomes littered with debris, the Head Referee will have a public address announcement made warning that a bench minor for delay of game may be assessed if situation continues or happens again. This rule does not apply to the celebration of milestones.

Rule 8.36 Displacement Of Goal

8.36.1 In the event that a goal post is deliberately displaced by the defending player or goalkeeper, the referee, at *their* discretion, may assess a minor penalty under the rule, award a penalty shot, or award a goal. Play shall continue under all circumstances until the referee stops play accordingly.

- 8.36.2 MINOR PENALTY - A minor penalty shall be imposed on any player, including the goalkeeper, who delays the game by deliberately displacing a goal post from its normal position. The referees shall stop play when the offending team gains possession of the ball.

If by reason of insufficient time in the regular playing time or by reason of penalties already imposed, the minor penalty assessed to a player for deliberately displacing their own goal post cannot be served in its entirety within the regular playing time of the game or at any time in overtime, a penalty shot shall be awarded against the offending team.

- 8.36.3 PENALTY SHOT - If a goalkeeper or player deliberately displaces the goal post during the course of a breakaway, a penalty shot will be awarded to the non-offending team. The referee will stop play immediately and award the penalty shot.
- 8.36.4 AWARDED GOAL - An automatic goal will be awarded to the non-offending team when the designated goalkeeper is on the bench and a defender deliberately displaces their own net in an attempt to thwart a scoring opportunity, in the discretion of the referee.
- 8.36.5 GOAL NET INTENTIONALLY MOVED - If a goalkeeper or a defensive player intentionally moves the goal to thwart a scoring opportunity, as per the excessively dislodged rule, play will be stopped immediately and a penalty shot will be awarded to the non-offending team.

If an offensive player intentionally moves the goal off its moorings, a minor penalty shall be assessed for unsportsmanlike conduct.

Rule 8.37 Obscene or Profane Language or Gestures by Players

- 8.37.1 OBSCENE AND PROFANE LANGUAGE BY PLAYERS - Players shall not use profane language on the floor or anywhere in the arena before, during or after a game.

A minor penalty shall be imposed to the offending player. Should the player continue to use obscene and profane language, at the discretion of the referee, the player shall be additionally assessed a misconduct penalty.

- 8.37.2 OBSCENE GESTURES BY PLAYERS - A bench minor penalty and game misconduct penalty shall be assessed to any player using an obscene gesture. Any player assessed a game misconduct penalty under this section shall automatically be suspended for the next game of their team.
- 8.37.3 OBSCENE AND PROFANE LANGUAGE OR GESTURES BY NON-PLAYING PERSONNEL - Club Executives, Coaches or other team staff shall not use obscene or profane language or vulgar gestures or derogatory gestures anywhere in the arena. For a first violation of this rule by any non-playing personnel a bench minor penalty shall be imposed.

A second offense by any non-playing personnel on the same team in the same game shall result in a bench minor penalty and game misconduct to the latest violator.

If any club executive, Coach, Equipment Manager, or Trainer is removed from the bench by order of the referee, *they* must not sit near the bench of their club nor in any way direct or attempt to direct the play of their club. Any obscene, profane or verbal abuse toward the officials post game shall be reported on the game sheet or special incident report.

- 8.37.4 DISCRIMINATORY LANGUAGE - Any player or non-playing personnel that uses discriminatory language based on race, religion, or gender shall be assessed a gross misconduct penalty for unsportsmanlike conduct.

Rule 8.38 Unsportsmanlike Conduct

- 8.38.1 In the enforcement of this rule, the Referee has the option of imposing a:
- Minor penalty; or
 - Misconduct; or
 - A game misconduct penalty.

Penalties should be assessed in ascending order beginning with a minor. A minimum of a bench minor penalty shall be imposed on any non-playing personnel or unidentified player who is guilty of unsportsmanlike conduct.

- 8.38.2 DISPUTES RULINGS OF REFEREE - A minor penalty shall be assessed to any player who challenges or disputes the rulings of any referee during the game.
- If the player persists in such challenge or dispute, a misconduct penalty shall be assessed and any further dispute will result in a game misconduct penalty being assessed to the offending player.
- 8.38.3 THROWS BALL AWAY/THROWS EQUIPMENT AWAY - A misconduct penalty shall be imposed on any player who intentionally knocks or shoots the ball out of the reach of a referee who is retrieving it provided there is a delay in the game or who deliberately throws any equipment out of the playing area.
- 8.38.4 ATTEMPTING TO DRAW A PENALTY - A minor penalty for unsportsmanlike conduct shall be imposed on a player who attempts to draw a penalty by their actions "taking a dive", or embellishing a legal or illegal hit by an opponent.
- 8.38.5 DISPUTES CALL BY BANGING THE BOARDS - A misconduct penalty shall be imposed on any player or players who bang the boards with their sticks or other objects at any time, showing disrespect for a referee's decision.
- In the event that the Coach, Trainer or Equipment Manager commits the infraction under this rule, a bench minor shall be imposed.
- 8.38.6 FAILS TO PROCEED DIRECTLY TO THE PENALTY BOX - Once a fight or altercation is broken up, any player who is penalized and who fails who to proceed directly and immediately to the penalty box, or who causes any delay by retrieving their equipment (gloves, sticks, etc. shall be delivered to the penalty box by teammates), shall be subject to additional penalties. Where coincidental penalties are imposed on players of both teams, the penalized players of the visiting team shall take their positions in the penalty box first.
- 8.38.7 CONTINUING TO FIGHT AFTER ORDERED TO STOP - Any player who persists in continuing or attempting to continue a fight or altercation after they have been verbally ordered by the referee to stop, or who resists a referee in the discharge of *their* duties shall, at the discretion of the referee, incur a misconduct or game misconduct penalty in addition to any other penalties incurred.
- 8.38.8 PERSISTS IN INCITING AN OPPONENT INTO A PENALTY - A minor penalty shall be imposed on any player who, partakes in any course of conduct (including threatening or abusive language or gestures or similar actions) designed to incite an opponent into incurring a penalty. If, after the assessment of a minor penalty, a player persists in any course of conduct for which they were previously assessed a minor penalty, they shall be assessed a misconduct.
- 8.38.9 PERSISTS IN SAME COURSE OF CONDUCT - If, after the assessment of a misconduct penalty, a player persists in any course of conduct for which they were previously assessed a misconduct penalty, they shall be assessed a game misconduct penalty.
- 8.38.10 THROWING OBJECTS ON FLOOR FROM BENCH - A bench minor penalty shall be imposed against the offending team if any player, Coach, Equipment Manager, Trainer or club executive throws anything on the floor during the process of the game or during the play of the game. Also, the incident shall be reported to the league or the appropriate sport governing body.
- 8.38.11 INTERFERENCE BY PLAYERS OR NON-PLAYING PERSONNEL WITH ANY OFFICIAL - A bench minor penalty shall be imposed against the offending team if any player, Coach, Equipment Manager, Trainer or club executive interferes in any manner with any game official including the referees, timekeepers and or game operations personnel in performance of their duties within the confines of the playing surface, players benches, penalty box areas and immediate exit and entry of the playing surface. The Head Referee may assess a major; major and game misconduct; match; or gross misconduct based on the severity of the conduct. The referee may assess further penalties under the Abuse of Officials' Rule if *they deem* them to be warranted.
- The Head Referee shall report on the game sheet or special incident report all cases in which a player becomes involved in interfering with the above noted personnel.
- 8.38.12 PLAYERS REMAINING IN THE REFEREES CREASE - A minor penalty shall be imposed on any player or players, who, except for the purpose of taking their positions in the penalty box, enter or remain in the referees crease while the referee is reporting to or consulting with any game official including the other referees, timekeeper, penalty timekeeper, official scorer or announcer. The player is subject to further penalties if their actions persist.
- 8.38.13 COMMUNICATION WITH REFEREES - Any player, including the captain who positions themselves at the referees' crease to converse with the referees without permission granted by the referees shall be automatically assessed an unsportsmanlike conduct minor penalty.

A complaint about a penalty is NOT a matter “relating to the interpretation of the rules” and a minor penalty shall be imposed against any captain, or other player making such a complaint.

- 8.38.14 UNSPORTSMANLIKE ACTIONS BY A PLAYER ON AN OPPONENT - A minor penalty shall be imposed on any player who is guilty of unsportsmanlike conduct including, but not limited to, hair pulling, biting, grabbing hold of facemask, throwing a ball at a player, throat slash gesture, etc.

The referee, at *their* discretion, may apply a major penalty, or major penalty and game misconduct, depending on the nature or severity of the incident.

The referee, at *their* discretion, may assess a gross misconduct or match penalty if, in *their* judgment, the player attempted to or deliberately injured their opponent by unsportsmanlike actions. Actions by players who display this unsportsmanlike conduct on opponents who are clearly unaware of any impending violence against them are deemed as more severe and shall be dealt with accordingly.

Actions by players who are not on the playing surface and become involved with players on the playing surface are deemed as more severe and shall be dealt with accordingly.

- 8.38.15 SPITTING AT A REFEREE - In addition to the minor penalty for unsportsmanlike conduct, a gross misconduct penalty may be assessed for spitting at the direction of the referee.

If a gross misconduct penalty is assessed under this rule, the player shall be automatically suspended for the next two regularly scheduled games.

- 8.38.16 PHYSICAL INTERFERENCE BY PLAYER WITH SPECTATORS - Any player who physically interferes with the spectators shall automatically incur a gross misconduct penalty and the referee shall report all such infractions. The referee shall report all cases in which a player becomes involved in an altercation with a spectator.

- 8.38.17 OPPONENTS NEAR OR IN OTHER TEAMS HUDDLES - This is not permitted. Players must remain on their side of the floor during all timeouts and related stoppages that involve team huddles at the team benches. Violation is an unsportsmanlike minor penalty.

- 8.38.18 PLAYERS STANDING ON PLAYERS BENCH - Players are not permitted to stand on the top of the bench seating at anytime during the course of the game. Failure to abide by this rule will result in an unsportsmanlike conduct penalty to the player. In the event coaches or non-playing personnel are deemed to be deliberately obstructing fans they are also subject to an unsportsmanlike conduct bench minor penalty.

Rule 8.39 Leaving Players' Bench or Penalty Box

- 8.39.1 No player may leave the players' bench or penalty box, for the purpose of starting an altercation or to enter an existing altercation. A player may leave the penalty box only at the end of the half or the expiration of their penalty.

Substitutions made prior to the altercation shall be permitted, provided the players so substituting do not enter the altercation. At the start of the altercation the benches shall be deemed frozen until a referee indicates that players are permitted to enter the floor.

A player who has entered the game on a legal line change and starts an altercation is subject to discipline in accordance with appropriate rules.

ALTERCATION DEFINITION - An altercation is a situation involving two (2) players, with at least one to be penalized.

- 8.39.2 MINOR PENALTY - Players who leave the players' benches and proceed onto the floor at the start of an altercation or during altercations prior to such time as the benches are released by a referee, including at the end of the quarters, halftime and at the end of the game, shall receive a bench minor penalty.

The rule does not preclude players from celebrating individual, team, or league milestone events.

- 8.39.3 GAME MISCONDUCT AND GAME SUSPENSION - The referee shall assess a game misconduct penalty, to the player(s) who was the first or second player to leave the players' bench or penalty box from either or both teams for the purpose of starting an

altercation or to enter an existing altercation.

The player(s) who leave the players' bench or penalty box shall be assessed an automatic game suspension.

- 8.39.4 LEAVING PENALTY BOX PRIOR TO PENALTY TIME EXPIRED - A penalized player who leaves the penalty box on their own accord before their penalty has expired, whether play is in progress or not, shall incur an additional minor penalty and game misconduct, in addition to serving the unexpired penalty time.
- If a player leaves the penalty box before their penalty is fully served, the penalty timekeeper shall note the time and signal the referees, who will stop the play when the offending player's team obtains possession of the ball.
- 8.39.5 LEAVING PENALTY BOX PRIOR TO PENALTY TIME EXPIRED, TIMEKEEPER ERROR - In the case of a player returning to the floor before their time has expired through an error of the penalty timekeeper, they are not to serve an additional penalty, but must serve the unexpired time.
- 8.39.6 ILLEGALLY ENTERING THE GAME AND INTERFERING WITH BALL CARRIER ON A BREAKAWAY - If a player of the attacking side in possession of the ball is on a breakaway, and while in that position is interfered with by the player of the opposing side who has illegally entered the game, the referee shall impose a penalty shot against the side to which the opposing player belongs. "Interfered" as per this rule, does not imply physical contact by the defender.
- 8.39.7 NON-PLAYING PERSONNEL ON FLOOR DURING PLAY - The referee shall impose a bench minor penalty against the team and report the incident when a Coach or General Manager is on the playing floor after the start of a quarter and before the end of the quarter. The Head Referee shall deem when the game is officially over and shall have the authority to remove the non-playing personnel off the players' bench and corridor.
- 8.39.8 ILLEGALLY ENTERING GAME WHEN THE TEAM IN VIOLATION SCORE - If a player illegally enters the game from their own players' bench or from the penalty box, any goal scored by their own team while they are illegally on the floor shall be disallowed, provided play has not been restarted, but all penalties imposed on either team shall be served as regular penalties.
- 8.39.9 ILLEGALLY RETURNING TO GAME AFTER BEING REMOVED FROM THE GAME BY AN OFFICIAL - Any player or non-playing personnel who has been ordered to the dressing room by the referee and returns to their bench area or to the floor for any reason shall be assessed an additional game misconduct penalty and shall be suspended automatically for the next game.

Rule 8.40 **Discipline**

- 8.40.1 The appropriate governing body may at their discretion, investigate any incident that occurs in connection with any pre-season, exhibition, regular season or playoff game and may assess any penalties including majors, misconducts, game misconducts, and addition sanctions for any offense committed during the course of a game or any aftermath thereof by the players, Coaches, Trainers, Equipment Managers or club executive, whether or not such offense has been penalized by the referee.

Rule 8.41 **General Application of the Rules**

- 8.41.1 All of the rules contained in this book shall be applicable in all pre-season, regular season, playoff and exhibition games. Game misconducts shall be accrued throughout all games in the regular season and playoffs for the entire season. Further, all suspensions incurred during the regular season shall carry into the playoffs. Further, all suspensions incurred at the end of the season or playoffs shall carry over to the next season.

SECTION 9 ADMINISTRATION OF COINCIDENTAL PENALTIES**Rule 9.1 Coincidental Penalties**











9.1.1 Coincidental penalties are administered by the following rules:

- i) Cancel as many penalties as possible.
- ii) If possible, cancel in a way to make the on-floor situation such that one team will play full strength and the other team is only one player short.
- iii) If possible, cancel in a way to avoid taking an extra player off the floor.
- iv) All coincidental major penalties with matching minors are offsetting. Substitute off the bench to the floor for the coincidental penalized players. There is no time on the penalty clocks for the coincidental penalties.
- v) All coincidental major penalties with non-matching minors require substitution in the penalty box for the non-matching minor penalty.
- vi) First in first out principle is used such that the player with the least amount of penalty time is released first.
- vii) When a player receives a minor and major they will serve the minor first.
- viii) If a goal has been allocated to a major you must continue to allocate to the major.
- ix) Penalty shots - allocate a penalty shot goal scored to the player with the least amount of time remaining on their minor penalty or one goal off the major penalty with the least amount of time remaining.
- x) Player receiving a major penalty will serve the penalty time in its entirety. The player is released upon expiry of the full penalty time, on the next non-technical stoppage of play. If two goals are scored on the major then the team may substitute a player from the team's player bench onto the floor.
- xi) If a player who has incurred penalty time that results in a substitute from the bench serving a portion of their time then the penalized player will only remain in the penalty box for the balance of time the sub is not serving. The substitute player always serves shorter time or equal time compared to the penalized player and the substitute player always returns to the floor before or at the same time as the penalized player. The substitute player never stays in the penalty box longer than the penalized player.
- xii) Match penalties - substitute must serve the penalty time. The substitute serves the full time regardless of the number of goals scored.
- xiii) A minor penalty is released when the penalized team is playing short-handed and a goal is scored against them.





APPENDIX A





REFEREE SIGNALS





Technical Signals

			
<p>30 Second Violation</p>	<p>10 Second Violation</p>	<p>4 Second Violation</p>	<p>Delayed Penalty</p>
			
<p>Possession, Direction of Play</p>		<p>Over and Back</p>	
			
<p>Second Count</p>		<p>Deflected Ball</p>	
			
<p>Ball Out of Bounds</p>	<p>Face-Off</p>		<p>Reset 30 Second Clock</p>

			
Goal Scored	Crease Violation	Illegal Pick/Screen	Time-Out







				
Loose Ball Push	Loose Ball Foul	Withholding Ball	Pinning: Withholding the Ball	







				
No Goal	Goaltender Interference	Penalty Shot	Hand Ball	







			
Minor Interference	Extra Attacker, 6 Players	Batting Ball in the net; no goal	

Penalty Infractions





				
Misconduct	Game Misconduct	High Sticking	Unsportsmanlike Conduct	Unsportsmanlike Conduct



						
Butt Ending	Holding	Holding	Tripping	Tripping	Hooking	Hooking

					
Checking from Behind	Slashing	Slashing	Kneeing	Kneeing	Fighting

					
Holding the Stick	Wrap Around	Boarding	Elbowing	Face Masking	Face Masking

Penalty Infractions

			
<p>Spearing</p>	<p>Head Butting; Spearing with the Head</p>	<p>Dangerous Contact to the Head</p>	<p>Cross Checking</p>

		
<p>Intentional Dead Ball Contact</p>	<p>Delay of the Game</p>	<p>Illegal Substitution; Too many players</p>

APPENDIX B

FIELD OF PLAY DIAGRAMS

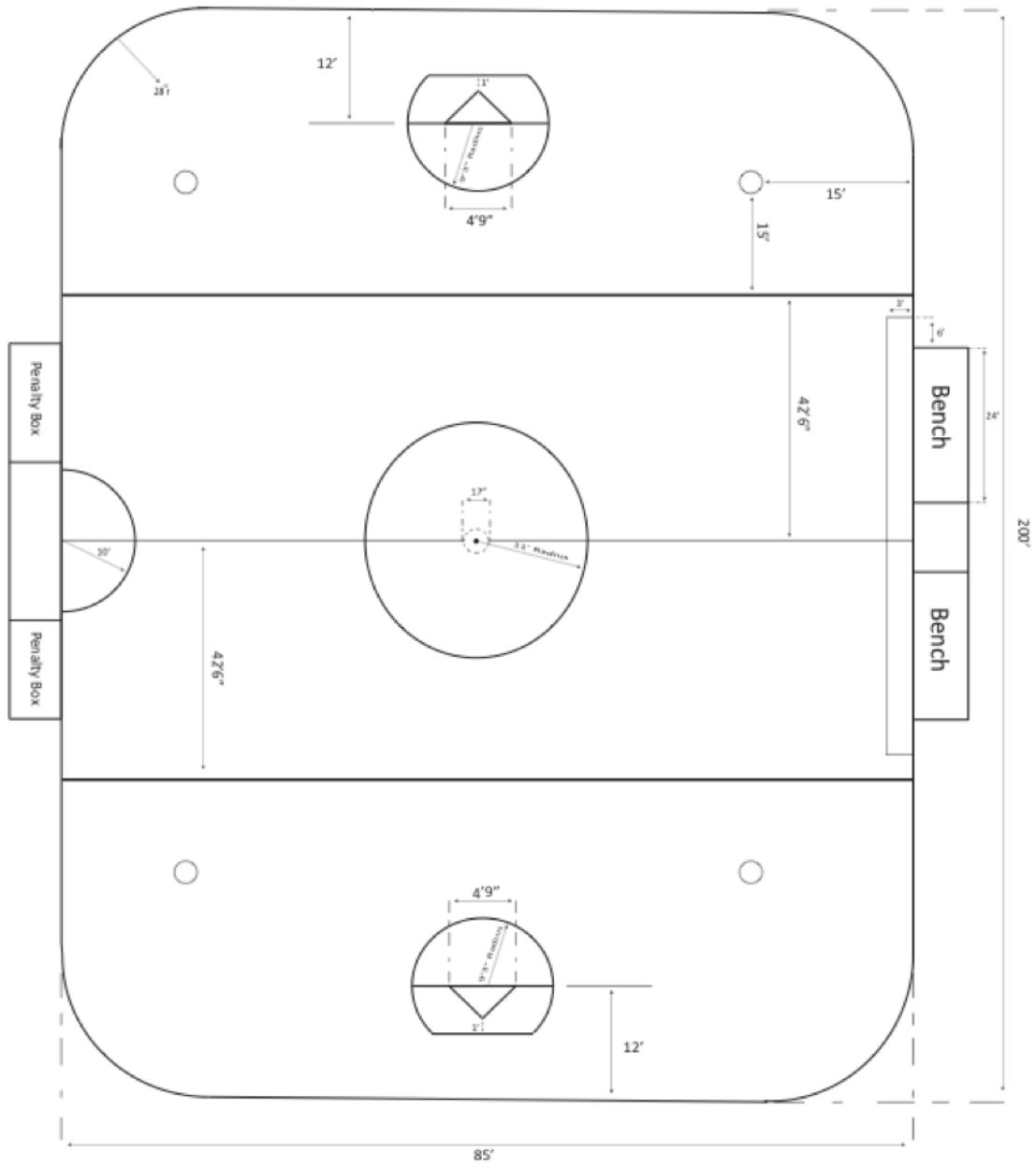

World Lacrosse Regulation Crease Area

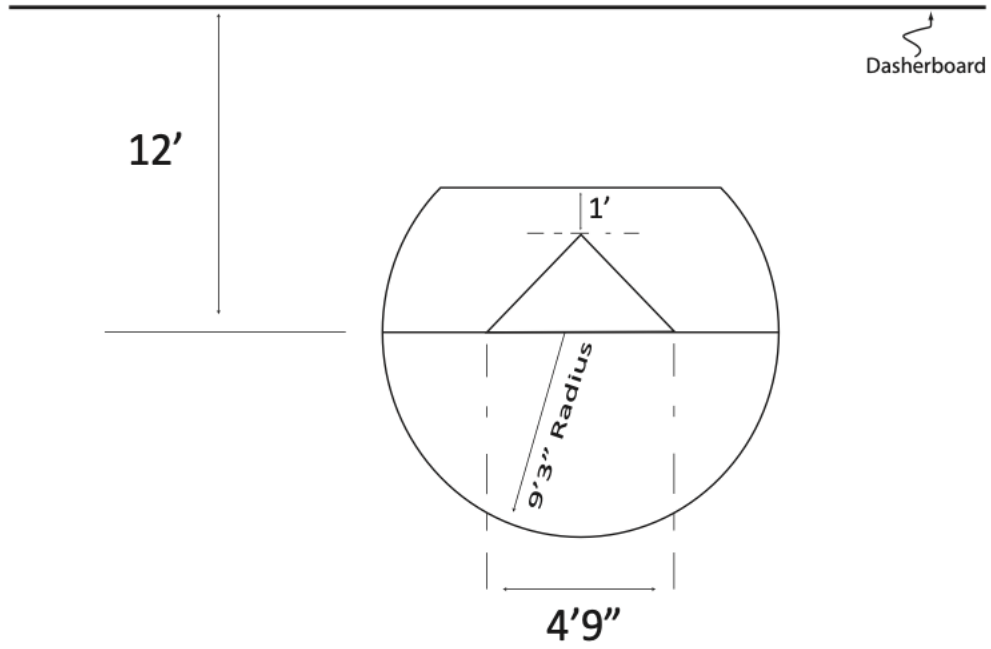

APPENDIX C**HISTORY OF RULE CHANGES****List of 2024 Changes (Editorial Only)**

Language changed to gender neutral references

Minor wording corrections and improvements

Rule 4.2.2 reference to # of eligible players corrected

List of 2016 WL approved rule changes

Rule #	Rule Name
5.7.5	Goalkeeper Equipment
5.6.1	Dangerous Equipment

2015

The WL 2015 Indoor Lacrosse Rule Book is the first edition of the WL Indoor Rule Book; therefore there are no rule changes.

APPENDIX D

GLOSSARY

Breakaway - A player with a 'BREAKAWAY' is defined as a player in control of the ball immediately transitioning from defense to offense with an unobstructed path to the goal and a reasonable scoring opportunity. Further interpretation is as follows: the breakaway shall be in a traditional 'north-south' direction with initial separation between attacker and defender, incorporating the origin from inside two imaginary lines from the goal posts to where the closest restraining line meets the dasher boards.

APPENDIX E

WORLD LACROSSE WORLD EVENT RULES

When playing in a World Lacrosse World Championship event any player or team personnel who is administered a major penalty for fighting or **gross misconduct for abuse of officials** shall receive the penalties as detailed in this rulebook. In addition, they shall not participate in any remaining games their team plays in that World Lacrosse World Championship.

Not participating in the game includes but is not limited to:

Shall not be listed on the game sheet;

Shall not dress in the team uniform;

Shall not be on the playing surface for the game or the team warmup;

Shall not be in the team bench area for the game or the team warmup;

Shall not be on the floor or bench area for any ceremonies or presentations after the game.

The event Discipline Committee shall automatically review any incident resulting in the administration of a major penalty for fighting and further penalties and sanctions may be administered as a result of the findings of the event Discipline Committee

NOTES

NOTES